

CITY OF BARRIE

Urban Design Manual

APRIL 2007
REVISED OCTOBER 2014



TABLE OF CONTENTS

	Page
1.0 INTRODUCTION	1
1.1 Historical Context	2
2.0 PHYSICAL ENVIRONMENT AND BUILDING SITING	4
2.1 Business Improvement Area (BIA) Streetscape	6
3.0 SITE CIRCULATION	7
3.1 Pedestrian Circulation	7
3.2 Vehicle Circulation and Parking	13
3.3 Parking Structures	20
3.4 Access Driveways	20
3.5 Drive-Through Facilities	29
3.6 Emergency Access	31
4.0 SITE SERVICES	32
5.0 LIGHTING	38
6.0 FENCING	42
7.0 ARCHITECTURAL DESIGN	45
7.1 Building Facades in the Downtown Barrie BIA	48
7.2 Heritage Resources	55
8.0 SIGNAGE	58
9.0 LANDSCAPE DESIGN	63
9.1 Landscape Strips	75
10.0 WATERFRONT	85
11.0 DEVELOPMENT ADJACENT TO RAILWAYS	87
12.0 TRANSIT	88
APPENDICES	89
APPENDIX 1 URBAN DESIGN GUIDELINE CHECKLIST	90
APPENDIX 2 TRANSPORTATION IMPACT STUDY REQUIREMENTS	97
APPENDIX 3 DEPARTMENTAL CONTACTS	107
APPENDIX 4 COMMUNITIES IN BLOOM	108
APPENDIX 5 HERITAGE BARRIE	110

REVISED OCTOBER 2014 AS PER STAFF REPORT PLN028-14 - APPENDIX "A"

1.0 INTRODUCTION

Good urban design seeks to create a safe, accessible, functional and attractive built environment. A partnership among the City, private sector investors, and respective professions, including Architects, Landscape Architects, Planners and Engineers, is required to achieve this objective.

Under Section 6.4 Urban Design Guidelines of the City of Barrie Official Plan, the City identifies the following as a goal:

“To provide, through urban design policies and guidelines, a framework for the development and maintenance of a convenient, safe, efficient and aesthetically pleasing urban environment.”

These Guidelines have been established in order to implement the existing urban design policies contained within the Official Plan, to provide a framework for establishing Barrie’s future urban form, and to ensure that new development is consistent with the City’s vision for urban design.

The Guidelines should be read in the context of the City’s Strategic Plan, the policies of the Official Plan, and in conjunction with requirements of various regulatory documents: the Zoning By-law, Site Plan Application Manual, Sign By-law, City of Barrie Standards, City of Barrie Lot Grading and Drainage Policies, By-law 2001-156 (Topsoil Removal By-law), By-law 2002-12 (Tree Cutting By-law), etc. In addition to these requirements, it is well understood that the Ontario Building Code, as it is amended from time to time, impacts quite significantly on the final form of development that is found in our community.

The Guidelines are intended to be flexible. They are not intended to prescribe specific design solutions but rather to express the preferred design objectives of the City. The development process is viewed as a cooperative venture between the City and the development industry. A successful development will achieve the City’s vision while meeting the individual needs of the proponent.

Design Standards and Policies, which are intended to implement the Guidelines, describe the City's requirements for development. They have been prepared to assist developers and their consultants in preparing development application submissions to the City of Barrie. These standards assume ideal conditions. There will be sites where due to competing objectives, or the inherent limitations of the specific site, it will not be possible to meet the standards. In such cases, City of Barrie staff should be consulted to discuss the best method of achieving the optimum design for the respective site.

In addition to the requirements set out in the manual, other legislation and regulations, including the Ontario Building Code, must be complied with.

This manual is intended to speed-up the approvals process by setting out the concerns of the City up-front. In setting out the concerns of the City ahead of time, time will not be wasted on developing and reviewing inappropriate development proposals. At the same time, they will provide City staff with a comprehensive framework for fairly and uniformly evaluating development proposals.

The City of Barrie Planning Services Department wishes to acknowledge the efforts of the City of Barrie Development Advisory Committee and the Barrie Land Developers Association in the preparation of this document.

1.1 Historical Context

Barrie's present urban form has been shaped by a number of factors, including the local economy, transportation, population growth, and its location on the west shore of Kempenfelt Bay. This form is very much a product of these factors linked together over the last century and a half.

The first evidence of the importance of the west shore of Kempenfelt Bay as a potential site for settlement was its role as a terminus of the Nine Mile Portage connecting Lake Ontario to Lake Huron. In the early 1880's, the Hudson Bay Company established a storehouse on the shores of Kempenfelt Bay. By the mid-1800's the area was serviced by a railway which became the City's main means of transportation and quickly developed into a social and economic focal

point. Industry and merchants quickly settled and developed businesses centering on the services provided by the railway.

In the first part of the 20th century, Barrie was changing rapidly. By 1930, the railway era had peaked and the highway era was beginning. Highway 400 was constructed in 1950, joining Barrie to Toronto and southern Ontario. The population of Barrie at this time was approximately 15,000. During the post-war era of the late 40's and 50's many large multi-national industries opened branches in Barrie which contributed to accelerated growth. Improved car and highways allowed many people who were employed in Toronto to commute to work from Barrie.

In the decades following, more and more people were attracted to the City. To accommodate this growth, the City expanded its municipal boundaries in 1959, 1982 and 1987. The 1990's saw tremendous growth and numerous changes in Barrie. In 1990 the population was estimated at 61,000. By the end of 1990's, population figures showed 100,000 people resided in the City. The City of Barrie is currently one of the fastest growing municipalities in Canada with an annual growth rate just under 4 per cent.

This tremendous growth has provided the residents of the City with many benefits including a new regional hospital, a new library, a new entertainment facility, and several new recreational facilities. In addition, the City has developed into the regional retail and service center for Central Ontario offering a wide array of retail, service, and employment opportunities.

The City has long recognized the waterfront as the City's most significant natural resource and a major contributor to the lifestyle enjoyed by its citizens. Protection and preservation of the City's waterfront has been one of the cornerstones of policy for the City of Barrie for a great number of years. Over the years, the City has actively acquired waterfront lands in order to develop a continuous public open space system encircling Kempenfelt Bay.

The City has also recognized the importance of protecting and enhancing the City's environmental features as a permanent and long term public resource. To this end, the City has acquired in excess of 470 hectares of environmental protection lands. These efforts along with the City's continuing investment in numerous infrastructure projects have all helped distinguish Barrie as central Ontario's premier waterfront city.

2.0 PHYSICAL ENVIRONMENT AND BUILDING SITING

DESIGN GUIDELINES

- A. *Incorporate development measures to appropriately address the physical environment of the site and adjacent lands when siting the building(s).*
- B. *Ensure compatibility of the development with adjacent area development. The visual character and unity of the neighbourhood should be enhanced through the subject development.*
- C. *Design buildings at a scale that is compatible with adjacent structures. New buildings should respect the established heights and setbacks in the neighbourhood.*
- D. *Incorporate natural features, major vegetation and topography into the design wherever it can be integrated with development objectives and the interests of adjoining land uses.*



This industrial development has incorporated existing vegetation in the site design.

- E. *Design outdoor spaces with regard to the programmed uses, the quality of views and the influences of sun and wind.*
- F. *Locate open storage, loading, garbage enclosures or equipment areas where they are not visibly prominent from public space(s) or street(s).*

- G. *Design the building setback at a pedestrian scale where appropriate and to contribute to a desirable streetscape.*
- H. *Locate active uses such as retail, service shops and restaurants at the street level to encourage pedestrian activity and interaction between internal spaces and the public realm.*



This residential development in the City Centre incorporates street level retail uses.

- I. *Locate buildings to meet public transit supportive measures.*
- J. *Design multi-use sites to reduce conflict.*
- K. *Site buildings to reduce the visibility of parking areas or treat parking areas with visual breaks (e.g. landscaping) to reduce the impact.*
- L. *Energy saving designs and features is encouraged. Orient buildings, outdoor spaces and pedestrian activity areas to maximize sunlight exposure during cooler months and shading during the warmer months.*
- M. *Minimize shadows cast on adjacent properties, especially outdoor spaces and pedestrian activity areas.*
- N. *Provide a variety of reliefs and architectural elements within the façade of lengthy “strip” buildings to enhance and diversify the visual presentation of the structure.*



A variety of architectural features and reliefs make for a more interesting presentation.

- O. Consider future site intensification and possible integration with adjacent lands including connections between parking lots.*
- P. Screen with landscaping external transformers located on arterial roads or highways and in areas of high visibility. Ensure that the landscaping does not prohibit access to operate and maintain the transformer.*
- Q. Locate buildings close to the street with unobstructed views of the street, parks or open spaces and neighbouring buildings.*
- R. Orient building entrances and windows toward the street to enhance surveillance.*
- S. Where appropriate, plan and design mixed land use development and supporting facilities to create and enhance surveillance.*

2.1 Business Improvement Area (BIA) Streetscape

DESIGN STANDARDS AND POLICIES

1. Development in the BIA shall incorporate landscaping, surface treatment, lighting and amenity features consistent with those currently found in the BIA (Refer to map on Page 49 for location of the BIA).

3.0 SITE CIRCULATION

3.1 Pedestrian Circulation

DESIGN GUIDELINES

- A. *Provide a safe and convenient and accessible pedestrian network from street to building, parking area to building, and building to building, that is visible from the street and buildings, and clear from visual obstructions.*
- B. *Provide pedestrian links between neighbouring properties where appropriate.*
- C. *Provide pedestrian walkways connecting municipal sidewalks to all public institutions, office developments, neighbourhood and larger commercial developments and multi-unit residential developments.*
- D. *Identify and emphasize major pedestrian routes through the use of signage, pavement markings, bollards, trees, appropriately scaled lighting and continuous hard surfaces.*



This pedestrian route is clearly defined through the use of contrasting surfaces.

- E. Minimize pedestrian and vehicular crossings on site.*
- F. Provide weather protected shelters and lighting at transit stops.*
- G. Install park and street furniture to create monitoring opportunities along pedestrian pathways and open areas.*
- H. Discourage dead ends, reducing the potential for entrapment and concealment.*
- I. Provide adequate lighting along pedestrian connections.*

DESIGN STANDARDS AND POLICIES

BARRIER FREE ACCESSIBILITY

On December 14, 2001, the Province of Ontario passed the Ontarians With Disabilities Act, 2001. The purpose of the Act is to improve access and opportunities for people with disabilities. The Act sets out the duties of the Municipalities that include making accessibility a consideration in land use planning and subdivision approval.

Designated Parking Spaces

1. Specially designated spaces shall be provided for use by persons with disabilities in parking lots associated with all public facilities, and in parking areas servicing commercial, industrial, institutional and multiple-family residential developments.

Location

2. Barrier free parking shall be located the shortest possible circulation distance to an accessible barrier free entrance, and no more than 30 metres.
3. Barrier free parking shall be located so that persons do not need to travel behind parked cars and/or across traffic.
4. Barrier free parking spaces shall be designed not to block curb cuts or ramps.
5. Barrier free parking shall be located away from designated fire routes, intersections, driveways, etc.
6. In mall parking areas, the required number of parking spaces should be divided to ensure parking at all public entrances to the mall and stores.

Quantity

7. Required parking for persons with disabilities must be provided as shown in Table 2.

Table 2 Required Disability Parking

Total Parking Spaces	Required Barrier Free Parking
6-50	1
51-100	2
Every 100 additional spaces	1

Note: Additional spaces may be required where warranted e.g. seniors residence.

Size

8. Car parking spaces shall:

- be at least 2.4 metres wide;
- have an adjacent access aisle at least 1.5 metres wide; and
- have access aisles clearly indicated by markings.

9. Two accessible parking spaces may share a common access aisle.

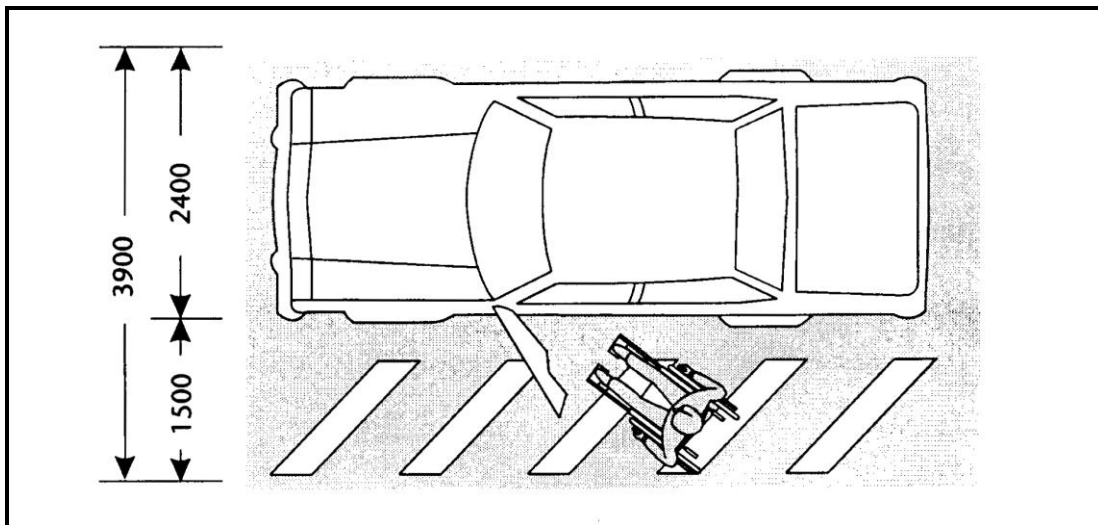

Figure 1 - Parking Stall

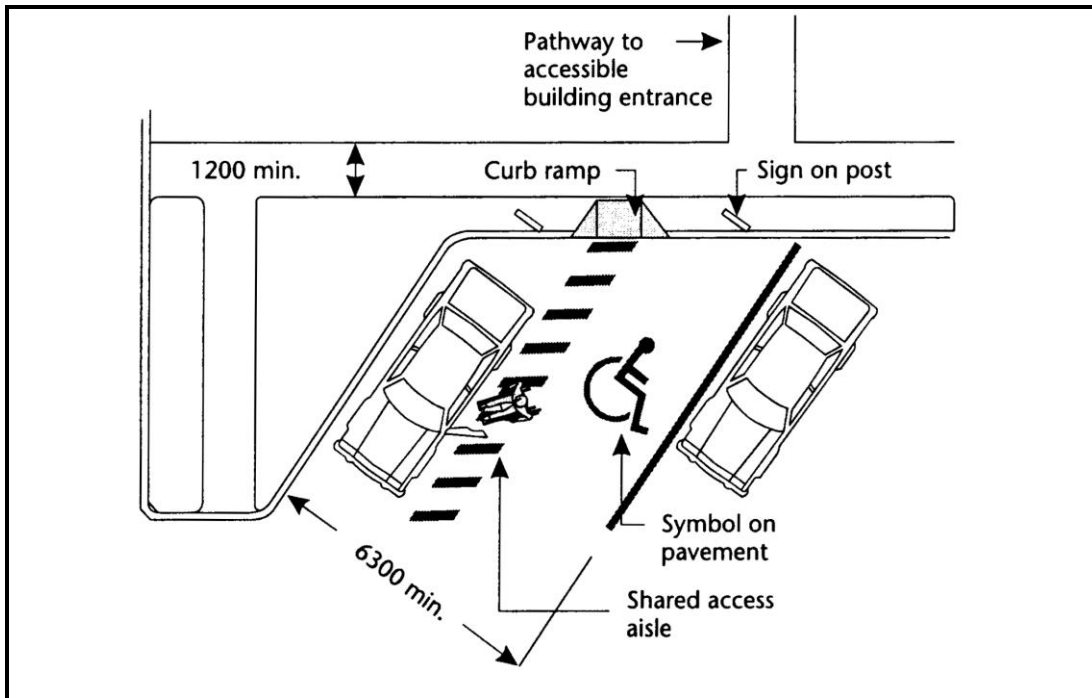

Figure 2 - Parking Stall, Diagonal to Curb

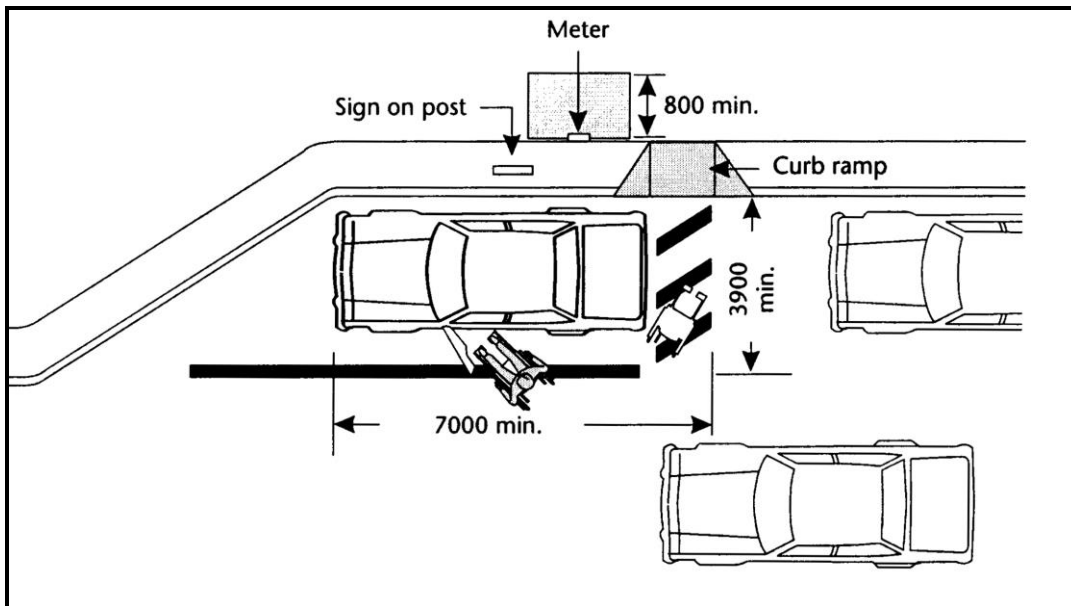

Figure 3 - Parallel Parking Stalls

10. Van parking spaces shall be at least 4.6 metres wide, except for parallel parking spaces, which shall be at least 2.6 metres wide by 7.4 metres long.
11. Van parking spaces shall have a height clearance of at least 2.75 metres at the parking space and along vehicle access and egress routes.

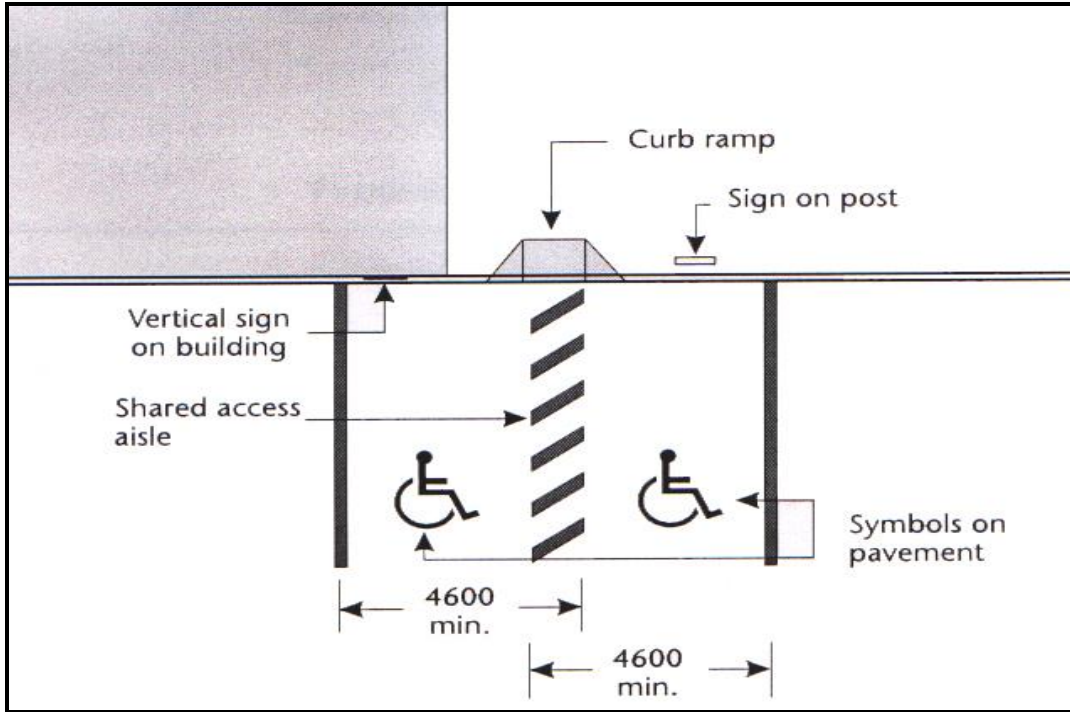

Figure 4 - Van Parking Stall

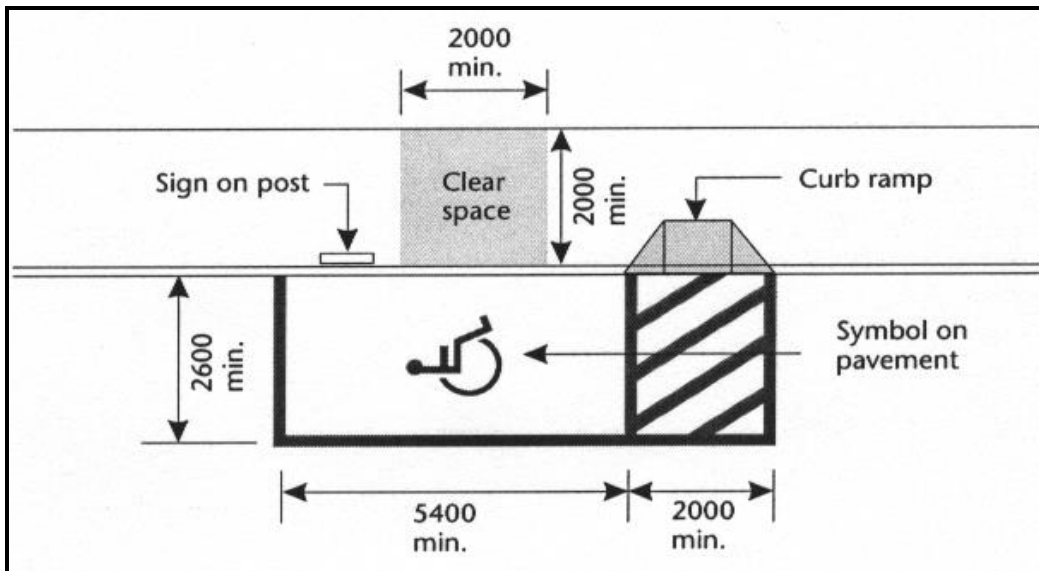

Figure 5 - Parallel Van Parking Stall

Signs

12. Barrier free parking stalls shall be designated as reserved for use by persons with disabilities by the following means:
 - a) vertical signs installed at a height between 1.5 metres and 2.5 metres above grade, and 0.6 metres to 2.0 metres from the curb edge or on a building face within 2.0 metres of the curb; and
 - b) symbols on the pavement that are at least 1.0 metre long, located in the center of the stall and are in a colour that strongly contrasts with the background pavement.
13. Where the location of designated parking areas for persons with disabilities is not obvious or is distant from the approach viewpoints, directional signs shall be placed along the route leading to the designated parking stalls.

Passenger Loading Zones

14. Passenger loading zones shall provide an access aisle at least 1.5 metres wide and 6.0 metres long adjacent and parallel to the vehicle pull up space and have a curb ramp where there are curbs between the access aisle and the vehicle pull-up space.

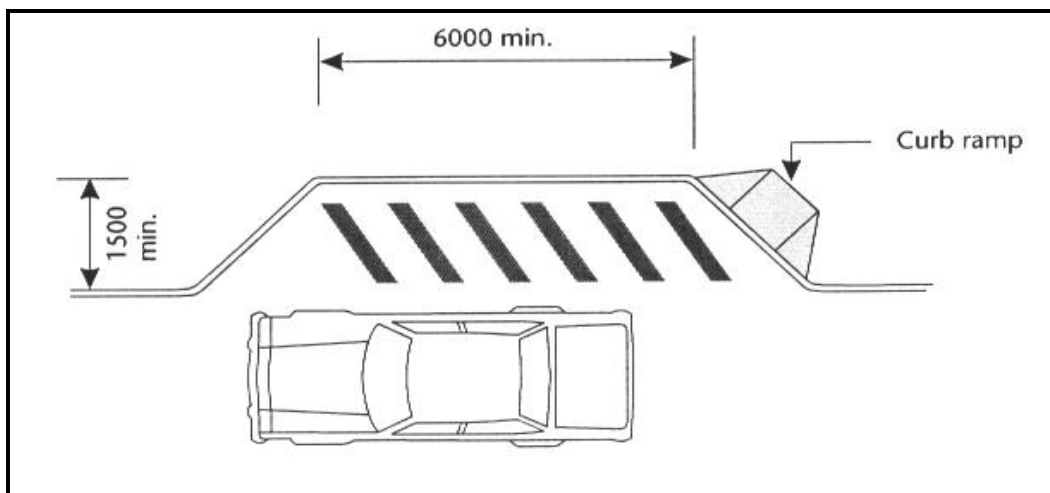

Figure 6 - Access Aisle at Passenger Loading Zone

15. A minimum vertical clearance of 2.75 metres shall be provided at accessible passenger loading zones and along vehicle access routes to such area from entrances.

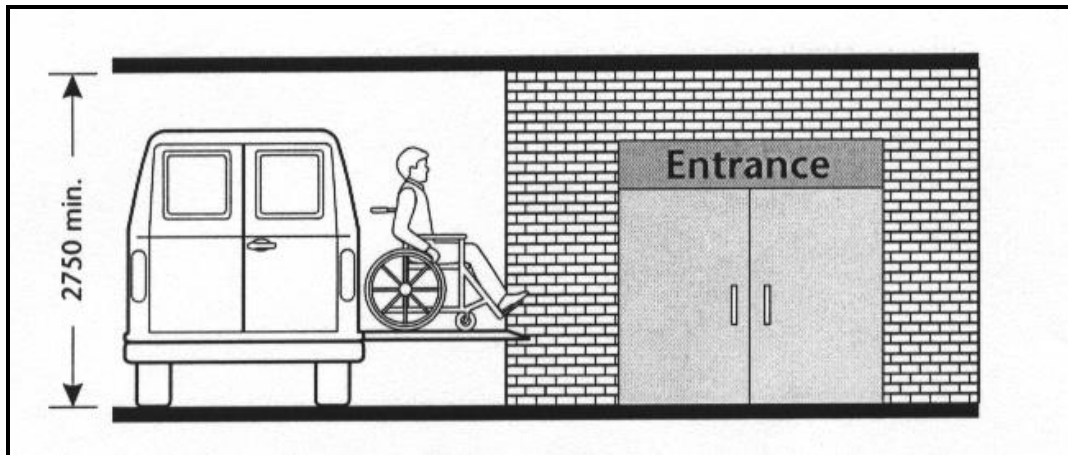

Figure 7 - Vertical Clearance at Passenger Loading Zone

Access, Ramps and Walkways

16. Principle entrances of all buildings will provide a barrier free transition between the outdoor and indoor environments.
17. Every barrier free access shall provide an unobstructed width of at least 1.1 metres for the passage of wheelchairs.
18. Locate barrier free main entrances adjacent to designated parking and drop-off facilities.
19. Walkways should be planned and constructed to provide a safe barrier free and efficient means of travel on site.
20. A barrier free path of travel consisting of curb cuts and ramps, as required, is to be provided between all barrier free building entrances, parking and drop-offs, municipal sidewalks, and outdoor amenities in accordance with this manual and the Ontario Building Code.
21. Exterior walks greater than 1 in 20 (5%) must be designed as ramps in accordance with the Ontario Building Code.
22. Locate ramps as close as possible to the most direct barrier free path of travel.
23. Locate ramps in a manner which compliments the overall design of the building and the site.

3.2 Vehicle Circulation and Parking

DESIGN GUIDELINES

- A. *Design parking and vehicular movement plans in a safe, convenient, and easily understood manner with appropriate turning radii and visibility.*
- B. *Provide parking areas with appropriate signage and adequate and uniform lighting for visibility and safety surveillance.*
- C. *Locate parking areas (particularly barrier free parking spaces) in close proximity to building entrances.*
- D. *Incorporate pedestrian circulation within the parking area.*
- E. *Link parking areas on abutting commercial properties to provide for movement between lots.*



Linked parking areas provides for safe and convenient vehicle movement between these two commercial properties.

- F. *Pave all parking and traffic circulation areas for light & heavy use as required.*

- G. *Clearly define primary vehicle routes on the site through the use of signage, curbing, bollards and line painting. Separate parking areas from primary vehicle routes and driveway entrances to public streets.*
- H. *Provide right angle parking spaces wherever possible with parallel parking only where circumstances dictate.*
- I. *Avoid dead-end parking aisles.*
- J. *Provide an adequate number of shopping cart corals in central locations throughout commercial parking areas.*



Shopping cart corals are distributed throughout the parking area.

- K. *Use areas located immediately adjacent to buildings or structures for walkways and/or landscaping and not for parking.*



The area located immediately adjacent to the building is used for pedestrian access and landscaping.

- L. Provide landscaping around the perimeter of parking areas and laneways. Use low level screening adjacent to public streets. Use dense screening (i.e. solid fences, coniferous plant material) when adjacent to conflicting land uses. Be sure that landscaping does not create hiding places or be a visual obstacle.*



Perimeter landscaping adjacent to the street.

M. Provide raised traffic islands to break up large parking areas and at a suitable scale and size to accommodate shrub and tree planting. Provide barrier free traffic islands where they are part of the pedestrian circulation system.



Landscaped traffic islands break up large parking areas and help delineate primary vehicle routes.

N. Consider ground cover, or a decorative hard surface for pedestrian uses, as a possible alternative to sod within raised traffic islands. Select parking lot plant material that is easy to maintain, hardy, and pollution, salt and drought tolerant.



Appropriate ground cover is an attractive alternative to sod.

- O. Ensure that parking lot planting does not obstruct views of approaching traffic, pedestrians, the street and building entrances.*
- P. Incorporate landscaping features in parking areas to provide shade and influence wind, erosion, noise and glare.*
- Q. Provide appropriate snow storage areas that do not interfere with pedestrian and vehicle circulation, or sensitive landscape plantings, as well as in an area that could be a visual obstacle.*
- R. Visitor parking areas should be located near main entrances of buildings and marked with signage, providing visitors with a direct route to and from the building.*

DESIGN STANDARDS AND POLICIES

SURFACE PARKING FACILITIES

1. Parking spaces shall be designed as right angle spaces wherever possible with parallel parking permitted only under circumstances of constraint.
2. Any off street parking spaces shall have a minimum width of 2.7 metres and a minimum length of 5.5 metres.
3. No required parking, loading or maneuvering area for vehicles related to the development is permitted on a public road.
4. Where both parallel and angle parking are served by one aisle, the minimum aisle width for angle parking shall apply.
5. All aisles serving angle parking shall be restricted to one-way traffic with the exception of 90 degree angle parking layouts.
6. In commercial areas, rights-of-way easements connecting adjacent properties will be encouraged. Plans showing connections between properties should be considered at the initial design stage.
7. Parking areas are to be clearly marked.
8. Parking areas shall provide appropriate signage and lighting for visibility and safety surveillance.

9. With the exception of industrial uses, continuous poured concrete curbing (15cm high) is generally required in the following locations:
- around traffic islands;
 - adjacent to vehicular parking stalls;
 - defining vehicular ingress and egress;
 - sidewalks adjacent to vehicular parking stalls and internal traffic routes; and
 - adjacent to landscaped areas.

Angle Parking

10. The minimum aisle width of off-street parking shall comply with the standards shown in Table 1.

Table 1 Aisle Width

Angle of Parking	Minimum Aisle Width
30 degrees	2.8 metres
45 degrees	3.4 metres
60 degrees	5.2 metres
90 degrees	6.4 metres

Parallel Parking

11. The width of parallel parking spaces shall not be less than 2.7 metres.
12. The length of parallel parking spaces shall not be less than 6.7 metres, except for the first and last row which may have a minimum length of 5.5 metres provided it is located a minimum of 1.5 metres from any intersection road, lane or obstruction.
13. One-way aisle width shall be a minimum of 3.7 metres.
14. Two-way aisle width shall be a minimum of 6.4 metres.

Loading Spaces

15. Any one loading space shall have a minimum width of 3.0 metres, a minimum length of 9.0 metres and a minimum vertical clearance of 4.0 metres and shall include additional areas as is necessary for the maneuvering of a truck-trailer either into or out of the loading space.
16. All loading spaces, driveways and maneuvering areas required shall be constructed and maintained with a stable surface which shall have a Portland cement or asphaltic binder.

17. Loading spaces for commercial and industrial developments are required in accordance with the standards shown in Table 2.

Table 2 Required Loading Spaces

Gross Floor Area of Building or Structure	Number of Spaces Required
0 – 999 square metres	0
1,000 – 2,999 square metres	1
3,000 – 7499 square metres	2
7,500 – 13,999 square metres	3
14,000 – 19,999 square metres	4

Plus one additional loading space for each additional 10,000 square metres over 19,999 square metres.

3.3 Parking Structures

DESIGN GUIDELINES

- A. *Integrate ground level, street oriented uses within parking structures where possible.*
- B. *Provide barrier free parking close to entrances and elevators.*
- C. *Provide signage to clearly identify the location of designated barrier free parking stalls.*
- D. *Ensure that parking structures include the following safety features:*
 - *Adequate and uniform lighting.*
 - *Clearly indicated exit routes and doors.*
 - *Bright coloured paint to improve light levels and reduce glare.*
 - *Mirrors and circular support columns to encourage open spaces and discourage potential entrapment and hiding areas.*
 - *Limit access to no more than two designated, monitored entrances/exits.*
- E. *Parking garages should be designed with maximum visibility and surveillance from the street, adjacent buildings and stairwells. They should be fully illuminated to minimize hiding places.*

- F. *Position all pedestrian entrances and exits next to vehicle entrances and in a visible location.*
- G. *Stairwells and elevators should be located in a central area, close to a main entrance. Stairwells should be without solid walls.*

3.4 Access Driveways

DESIGN GUIDELINES

- A. *Locate site access in a manner that reduces traffic conflict and confusion.*
- B. *Provide mutual driveways where appropriate, especially along major collector and arterial roads to minimize the number of driveways.*
- C. *Ensure pedestrian safety and maximize visibility through the proper location of driveways.*
- D. *Maximize the distance between site access driveways as well as the distance between site access driveways and street intersections. (Refer to Figure 3.2.8.2 and 3.2.9.3 in the Geometric Design Guide for Canadian Roads, Transportation Association of Canada (TAC), 1999 Edition.)*

Figure 3.2.8.2 Suggested Minimum Corner Clearances to Accesses or Public Lanes at Major Intersections

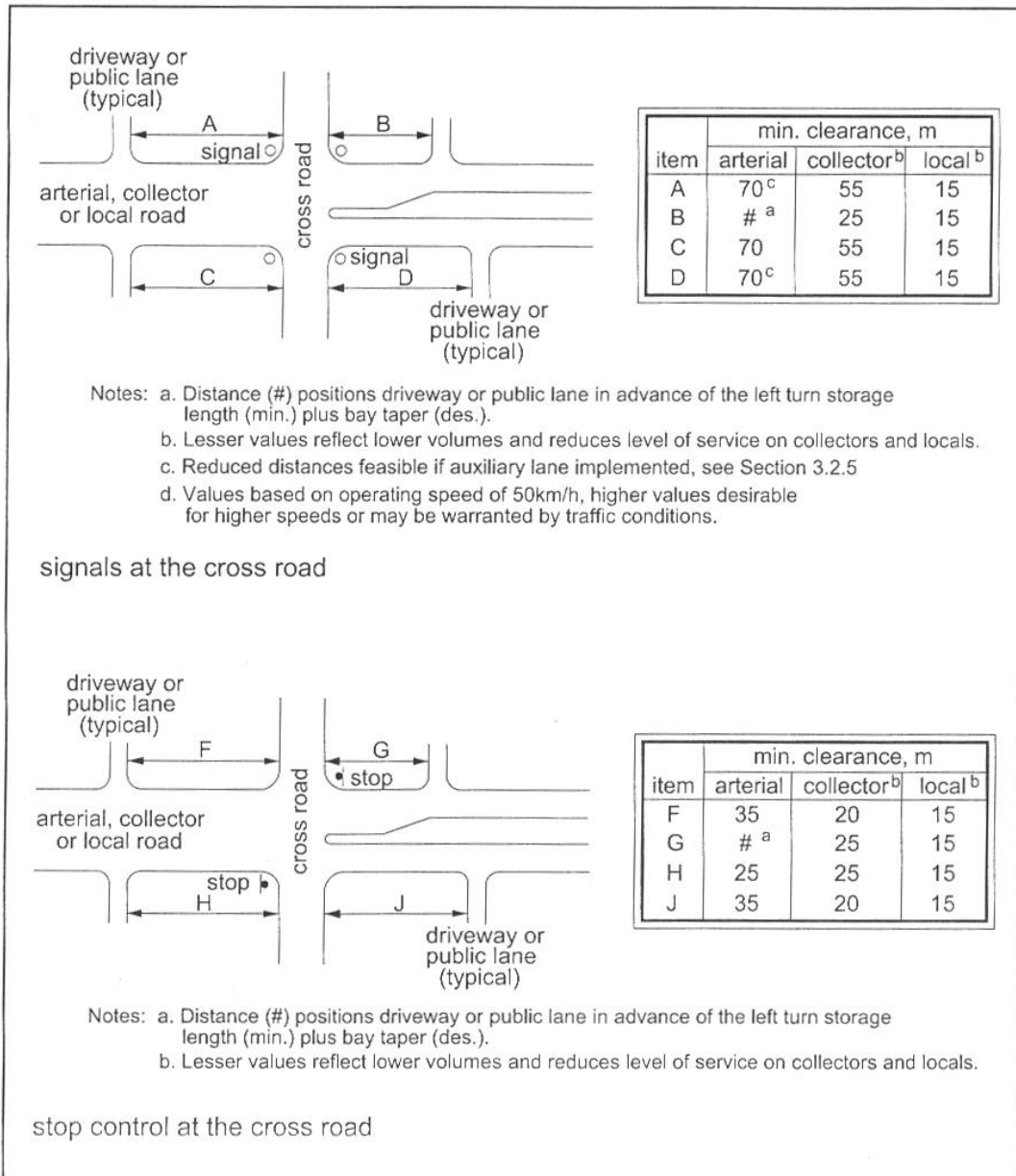
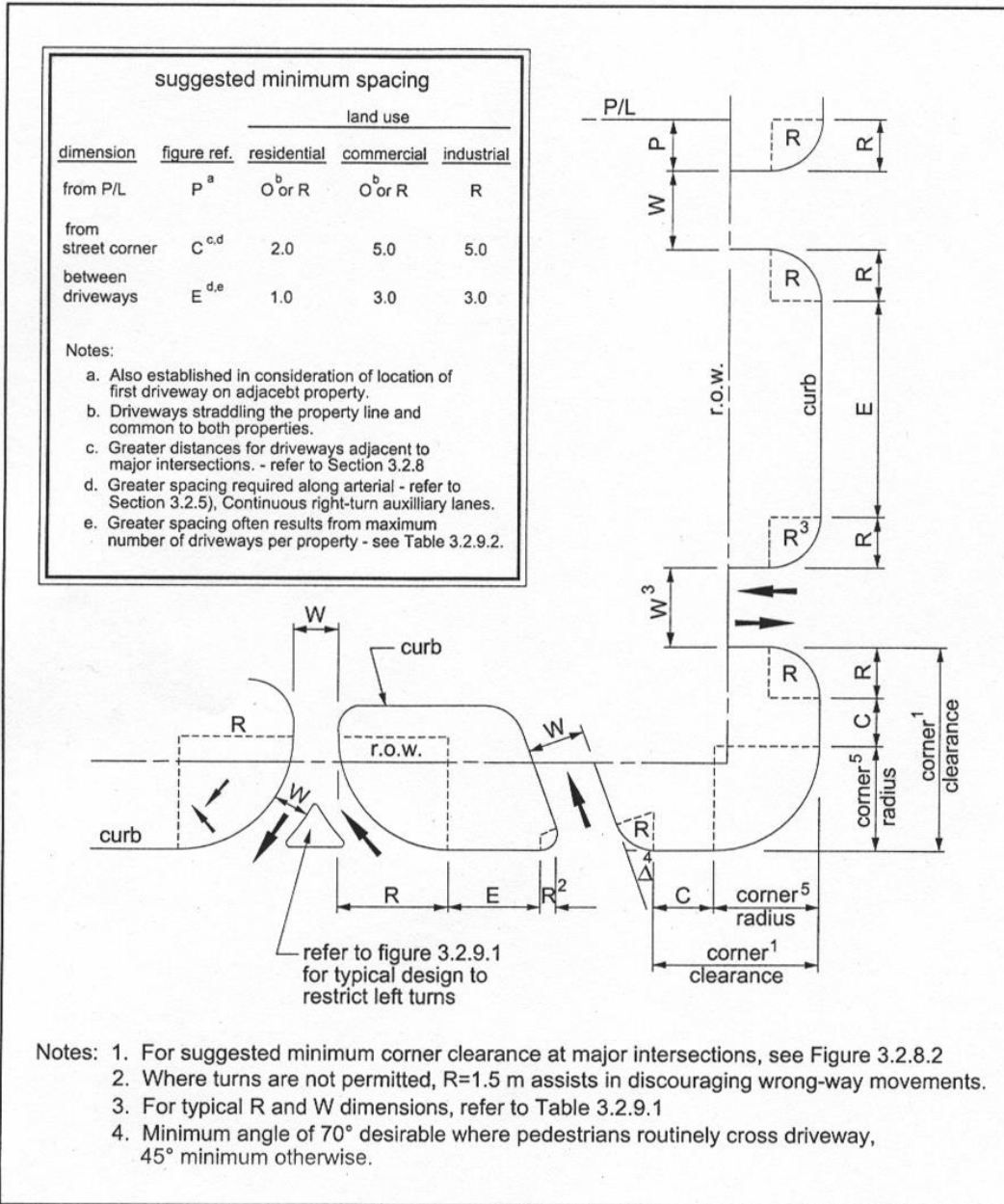

Figure 3.2.9.3 Driveway Spacing Guidelines - Locals and Collectors



DESIGN STANDARDS AND POLICIES

1. Site access is to be located in such a manner as to reduce traffic conflict and confusion. Each site is generally limited to one access point unless warranted by a Traffic Impact Study to the satisfaction of the Engineering Department. The use of mutual access points with adjacent properties is encouraged.
2. Developments adjacent to arterials, parkways, and collector roads may be required to provide a Traffic Impact Study completed by an experienced Traffic Consulting Engineer with letters of reference to the satisfaction of the Engineering Department. This Traffic Impact Study is to be in conformity to the City of Barrie guidelines for the preparation of Transportation Impact Studies (refer to Appendix 2), the Official Plan requirements, and the current City of Barrie Transportation Study. The consultant will be responsible for the implementation of the recommendations of the approved study and for the installation and certification upon its completion.
3. The following size of developments are generally exempt from the requirements of undertaking a traffic study, however, site access and circulation design must be supported and justified.
 - Residential (apartments) 75 units
 - Hotel 75 hotel rooms
 - Day Care Centre 400 m² G.F.A.
 - Office 2,000 m² G.F.A.
 - Medical Office 1,500 m² G.F.A.
 - Retail Shopping Centre 400 m² G.F.A.
 - Convenience Store 100 m² G.F.A.
 - Sit Down Restaurant 500 m² G.F.A.
 - Fast Food Restaurant 100 m² G.F.A.
 - Bank 400 m² G.F.A.
4. The following size of developments generally require a traffic study limited to a review of the driveway traffic operation to ensure that the access is appropriate and that there is little impact on adjacent properties and abutting streets. If site traffic is oriented all in one direction, the City may require analysis of the nearest major intersection to ensure that capacity is available on the street system.
 - Residential (apartments) 225 units
 - Hotel 225 hotel rooms

- Day Care Centre 1,200 m² G.F.A.
- Office 6,000 m² G.F.A.
- Medical Office 4,500 m² G.F.A.
- Retail Shopping Centre 1,200 m² G.F.A.
- Convenience Store 300 m² G.F.A.
- Sit Down Restaurant 1,500 m² G.F.A.
- Fast Food Restaurant 300 m² G.F.A.
- Bank 1,200 m² G.F.A.

5. For developments of larger size, generally a traffic study is required to determine the impact of development on the street system and recommend improvements that are required to provide a good level of traffic operation on the adjacent street system and adequate access to the site.

Location of Access Driveways

6. Driveways are not permitted close to intersections. The control distance on intersection approaches in which no driveway is permitted varies with the functional classification as described in Table 3.

Table 3

Functional Class	Control Distance
Arterial	30 m
Major Collector	20 m
Minor Collector	10 m
Local	6 m

Spacing of Driveways by Functional Class of Road

7. The required spacing of driveways based on the functional class of a road is described in Table 4.

Table 4

Functional Class	Driveway Spacing
Arterial	1 per 120 m of frontage
Major Collector	1 per 60 m of frontage
Minor Collector	2 per 30 m of frontage
Local	No Control

Spacing of Driveways by Lot Characteristic

8. Where access is provided according to the functional class of road, the following establishes the number and spacing of driveways based on the frontage available and the type and size of development.

Driveways for Properties Used for Public, Commercial, Industrial or Apartment Development

- a) Two-way driveways with raised center divider medians shall have a minimum median width of 2 metres and a maximum median width of 4 metres.
- b) The maximum number of driveways permitted shall be governed by the amount of frontage owned and in accordance with Table 5.

Table 5

Frontage	No. of Driveways
Less than 20 m	1 two-way
20 m to 33 m	1 two-way or 2 one-way
34 m to 45 m	2 two-way
46 m to 150 m	1 two-way and 2 one-way or 2 two-way
Greater than 150 m	reviewed on individual basis

- c) On a corner lot or a lot abutting on more than one street, the foregoing restrictions apply to each frontage separately and at high volume driveways acceleration and deceleration lanes or taper may be required.
- d) In the case of:
 - i. a shopping center, public parking lot or parking lot provided for the use of customers of a retail or wholesale business, public garage (excluding automobile service stations) or personal service or eating establishment which has a parking area which can accommodate the number of parking spaces set out in Column 1 in Table 6;
 - ii. a hotel, office building, apartment dwelling, property used for public purposes or industrial development which has a parking area which can accommodate the number of parking spaces set out in Column 2 in Table 6;

No driveway is permitted within an intersection or in such a manner that the distance between the nearest limit of a driveway and the nearest intersection right-of-way line or its extension is less than the distance set out in Column 3 in Table 6, and in no case less than 6 metres from the end of the present or planned radius and if an exclusive or channelized right turn lane is present or planned, the location will be negotiated; and the distance between the nearest limit of a driveway intended for two-way vehicular traffic and any other driveway servicing the same property is less than the distance set out in Column 4 in Table 6. All distances referred to are to be measured at the right-of-way line.

Table 6

Column 1	Column 2	Column 3	Column 4
No. of parking spaces	No. of parking spaces	Distance between driveway & nearest right-of-way	Distance between two-way driveways
Up to 14	6 to 29	20	15
25 to 29	30 to 59	30	30
30 to 59	60 to 89	45	45
60 to 89	90 or more	60	60
90 or more		75	75

- e) In case of driveways for other properties, the distance between the nearest limits of a driveway intended for two-way vehicular traffic and any other driveway for the same property shall be a minimum of 10 metres measured at the street line and curb line or edge of roadway.
- f) The distance between the nearest limits of two one-way driveways to or from the same property shall be a minimum of 10 metres measured at the street line and curb line or edge of roadway. Notwithstanding the foregoing there should be not more than two one-way driveways on any given 34 metres frontage.
- g) Where it is impossible to comply with the requirements on any frontage, driveways are permitted only on the road carrying the lesser volume of vehicular traffic and the driveway shall be located as far removed from the nearest intersection as possible. In cases where the vehicular traffic volumes on the abutting roads are essentially

equal, the driveway shall be located as far removed as possible from the nearest intersection and on the street with the lowest future traffic projections.

- h) Supplementary to the foregoing, no driveway is permitted within the intersection or on an existing planned corner radius of an intersection or within 6 metres of the point of tangency of such radius or in such manner that the distance between the nearest limit of the driveway and the intersecting right-of-way line or its extension is less than 6 metres.
- i) No driveway for commercial property other than a mutual driveway is permitted within 3 metres of any adjoining property measured at the right-of-way line.

Driveways for Properties Used for Other Than Public, Commercial, Industrial or Apartment Development

- a) Two-way driveways with medians shall have a minimum median width of 2 metres and a maximum median width of 4 metres.
- b) Mutual driveways may be acceptable and in some cases desirable.
- c) A driveway shall be permitted only for the purpose of providing access to a parking space.
- d) On a corner lot or a lot abutting on more than one road allowance, the minimum distance between the nearest limit of a driveway and the intersecting right-of-way or its extension shall be 6 metres.
- e) No driveway shall be located within 0.3 metres of any adjacent property measured at the right-of-way and at the curb or edge of roadway except in the case of a mutual driveway serving two adjacent properties.
- f) No driveway shall be located within an intersection except where the entire property frontage is situated within the intersection or within 3 metres of the limits of an intersection in which case a driveway may be permitted provided that the driveway is not located within an area used or intended to be used as a pedestrian crossing.

Angled Driveways

- 9. Angled driveways are suitable as one-way driveways to accommodate right turns in and/or right turns out.

- 10. Where the angle of the driveway is between 60° and 75°, paired angled driveways shall not be used on two-way roads nor shall two-way traffic be permitted on the driveways. Two-way traffic is permitted on a driveway with an angle of 75° to 90°.

Angled Driveway Geometry

- 11. The angle between the road and the driveway shall not be less than 60° for one-way driveways. Two-way driveways shall be 90° but angles of 75° to 90° may be considered in special circumstances.
- 12. The standard width of the driveway shall be between 7 and 9 metres.
- 13. The outside return radius shall not be less than 3 metres and the inside return radius shall not be less than 2 metres.
- 14. At driveways on high volume roads, the use of a taper leading to the outside return radius may be required.

Driveway Design

- 15. Driveways shall be constructed to a quality equivalent to a minimum of 50mm HL3 asphalt on a minimum of 200mm of Granular ‘A’ for Residential and 250mm of Granular ‘A’ for Commercial/Industrial or alternative equivalent surface material as approved by the City (i.e. paving stone, concrete).
- 16. Entrance aprons on municipal boulevards shall be paved and constructed as per City standards as described in Table 7.

Table 7

Land Use	Road Type	Entrance Width (m)		Radius (m)
		One-Lane	Two-Lane	
Low Density Residential	Arterial	4	6	5
	Collector	4	6	2
	Local	4	6	0
Multiple Residential	Arterial	6	9	8
	Collector	5	8	6
	Local	5	6	5

Minor Commercial	Arterial	6	9	8
	Collector	5	9	6
	Local	5	8	5
Major Commercial*	Arterial	8	11	9
	Collector	6	9	8
	Local	6	9	5
Industrial*	Arterial	9	12	12
	Collector	6	11	9
	Local	6	9	6

* or as required by specific vehicle conditions

17. Driveway grades shall be a minimum of 2% and a maximum of 7%.

3.5 Drive-Through Facilities

DESIGN GUIDELINES

- A. *Provide sufficient on-site vehicle stacking spaces in drive-through facilities.*

High Generator *72 metres (i.e., Tim Horton's, McDonald's)*

Medium Generator *54 metres (i.e., Wendy's, Country Style)*

Low Generator *36 metres (i.e., Taco Bell, Harvey's)*

(Distances measured from drive-through window.)

- B. *Locate stacking lanes to minimize disruption to internal traffic flows, site access and pedestrian routes, and that do not interfere with other on site uses, services and utilities.*

- C. *Use raised traffic islands or knock down barriers to separate vehicle stacking lanes from main parking areas.*



This vehicle stacking lane is physically separated from the parking area.

D. Screen vehicles stacking lanes from adjacent residential areas to avoid illumination from vehicle headlights but should not create hiding places.



A combination of fencing and landscaping screens this stacking lane from the adjacent residential use.

E. Position and orient menu boards and order stations away from adjacent residential areas.

F. *Lighting should be provided at drive through window and the queuing lane.*

3.6 Emergency Access

DESIGN GUIDELINES

- A. *Ensure that emergency vehicles can gain easy access to, within and from the site.*
- B. *Provide on-site vehicle circulation and parking which does not conflict with the use of emergency access routes.*
- C. *Provide clear pedestrian passage to and from the building to enhance emergency access and exit.*
- D. *Identify the location of hydrants and sprinkler connections through the use of signage and bollards.*

DESIGN STANDARDS AND POLICIES

1. Emergency access routes shall be provided in accordance with the Ontario Building Code.
2. Every building exceeding 3 stories in height or 600m² in gross floor area shall provide an emergency access route.
3. The emergency access route shall have direct access to a municipal road and shall be identified on the site plan.
4. The pavement of the route must be appropriately load bearing.
5. Appropriate emergency vehicle turning radii shall be provided where applicable.
6. Identification of building classification, fire protection methods (i.e. sprinklered) to be shown on site plan.
7. An emergency access route shall be designed as follows unless approved otherwise:
 - minimum width 6.4 metres;
 - minimum centre line turning radius 12 metres;
 - minimum overhead clearance 5 metres; and
 - maximum dead end route 90 metres.
8. Emergency access signs shall be located at both ends of the emergency access.

4.0 SITE SERVICES

DESIGN GUIDELINES

- A. *Ensure that loading bays, recycling areas and garbage storage facilities are located away from public streets or screened through the use of landscaping, walls and buildings but not to create entrapment areas and hiding places.*



This recycling area is screened from view through the use of a wall constructed with the same materials as the main building.

- B. *Eliminate conflict between service/loading areas and vehicle/pedestrian routes.*
- C. *Design on-site circulation to eliminate reversing or maneuvering on public streets.*
- D. *Orient continuous sources of noise and odour away from sensitive adjacent uses. Use noise attenuation measures where necessary.*
- E. *Screen commercial outdoor storage from public streets and adjacent residential uses.*

- F. Locate recycling and garbage handling within the primary building or within an accessory structure. Ensure adequate access for the related service vehicle and a loading space located adjacent to the recycling and garbage handling area.*
- G. Construct accessory recycling and garbage handling structures as an enclosed building including roof and door/gate and with materials consistent with the primary building. Wood structures are discouraged.*



The design of this garbage enclosure complements the main building.

- H. Store all recycling and garbage bins within the structure.*
- I. Provide interior waste storage areas for restaurants and commercial buildings providing food services.*
- J. Locate utilities underground to improve the appearance of the development. Where above ground utilities are necessary, ensure compatibility with other site features.*
- K. Provide adequate lighting to ensure safety.*

DESIGN STANDARDS AND POLICIES

Water, Storm and Sanitary Connection Locations

1. Sanitary, storm and water service connection locations for industrial and commercial developments shall be in accordance with BSD-26.

Water Service

2. Water service connections shall be in accordance with BSD-48 and BSD-49.
3. Water service lines shall comply with Part 7 of the Ontario Building Code.
4. The domestic and fire service installations shall be in accordance with ANST/AWWA Standard C651-92 construction and disinfection methods. Materials for water services on private property shall comply with the City of Barrie Water Distribution Standards and the National Fire Protection Act up to the water meter. The water service after the meter shall comply with the Ontario Building Code.
5. A tapping sleeve and valve into the watermain is required for any service of 100 mm or greater. The service pipe material must be ductile iron from the restraining flanges to a minimum 3 metres outside foundation BSD-61.
6. Any water service 50 mm and less shall be type “k” soft copper. PVC pipe must be used where aggressive soils are present.
7. All domestic water services 38 mm and larger require a by-pass around the meter, complete with shut-off valve in accordance with BSD-58.
8. The owner shall install one bulk meter in a multiple unit building, industrial building and commercial building.
9. The mechanical room should be located on the ground floor.

Fire Protection

10. Adequate water supply, hydrants and fire department connections shall be provided in accordance with the Ontario Building Code.

11. Where a fire hydrant is installed on the fire service, a valve and valve box is required on the service before it enters the building.
12. The face of the building must be within 92 metres of a fire hydrant.
13. All Siamese connections must be located within 45 metres of a fire hydrant.
14. All fire hydrant valves should be located 0.7 metres from the hydrant.
15. An anchor tee and valve should be provided for all fire hydrants.
16. All private fire hydrants shall be painted “fire hydrant red”.

Sanitary Service

17. The sizing, material and installation of sanitary sewers shall comply with the Ontario Building Code.
18. One sanitary connection to the municipal main per development is permitted.
19. The minimum diameter sanitary service for commercial and industrial building is 150 mm in diameter and placed at a grade of no less than 2% as per the City of Barrie Sanitary Drainage Policies and Standards.
20. A sanitary inspection manhole as per OPSD standard 701.010 is to be provided for all commercial, institutional and industrial developments. These manholes are to be located in an accessible location within the project’s property boundaries.
21. All connections to new sanitary mains shall be pre-manufactured, fabricated tees. Connections to existing sanitary sewer shall be made with approved factory made tees or inserta-tees in strict accordance to manufacturer’s guidelines.

Storm Service

22. All connections to the storm main shall be made with a storm manhole or approved factory tee connection as per OPSD-708.01 or 708.03.

Electrical Service

23. Electrical service shall be in accordance with the standards and policies of Barrie Hydro.
24. Developments shall be serviced with pad mounted transformers and underground conductors.

25. Developments within the BIA shall be serviced with underground conductors.

Lot Grading

26. A Stormwater Management Report (SWMP) is required to the satisfaction of the Engineering Department for development not covered under a previously approved SMWP.

27. Within the site, lot grading is to conform to the “City of Barrie Lot Grading and Drainage Policies” which require the following grading criteria:

- driveway grades - 2% to 7% with positive grading to the municipal right of way;
- other asphalt grades - 0.5% to 7%;
- drainage swales are to be a minimum grade of 2% fall;
- sodded areas - 2% to 10%;
- graded slopes and landscaped berms are to be a maximum 3H:1V slope.

28. All surface drainage shall be self contained, collected and discharged at a location approved by the City. Drainage of abutting properties shall not be adversely affected.

29. Topsoil removal is regulated by City of Barrie By-law 2001-156.

30. No foundation or roof drains are to be connected to the storm sewer as per City of Barrie drainage policies, but rather to splash pads on landscaped areas or other approved by the City.

31. The maximum permitted ponding depth is 0.3 metres in parking areas, and 0.5 metres in approved landscaped areas (excluding rear yards, amenity areas and minimum landscape strip areas).

32. An overland flow route shall be provided in the event that the underground storm drainage system fails. Maximum permitted ponding depths shall not be exceeded.

33. Municipal boulevards must be graded between 2% and 7% maximum.

34. The grading plan should respect natural grades wherever possible, however, in the event that retaining walls are required, they shall comply to the requirements of the Ontario Building Code, By-law 82-45, as amended, and Zoning By-law 85-95.

35. Proposed elevations along all property lines must be compatible with the existing adjacent elevations, or approved lot grading plan for the development.

Sidewalks

36. A public sidewalk must be installed across the street frontage per the following City standards:
- 0.5% minimum to 7% maximum grade with a minimum cross fall of 2%
 - no steps are permitted
 - width – 1.5 metres minimum
 - base – 150mm Granular 'A' unless otherwise specified by the City
 - thickness – 125mm (150mm at residential driveway, 200mm with reinforcement if required at commercial/industrial driveways)
 - concrete strength – minimum 30 MPa @ 28 days
 - sidewalk to be continuous through all driveways and entrances.
37. Minimum walkway width shall be 1.5 metres and high capacity areas shall provide a minimum width of 1.8 metres (e.g. commercial plazas).
38. Pedestrian walkways shall be raised 0.15 metres from the parking areas to provide definition and pedestrian safety and shall be hard surfaced with material other than asphalt.
39. Depressed curbs should be located adjacent to handicapped parking spaces and within barrier free circulation routes.

Daylighting Triangles

40. Lots located at street intersections shall provide daylighting triangles in accordance with BSD-12.

5.0 LIGHTING

DESIGN GUIDELINES

- A. *Select exterior lighting fixtures based on compatibility with the architectural design of the building and the character of the neighbourhood and enhance the ability for surveillance.*



The lighting fixtures are compatible with the architectural design of the building.

- B. *Design site lighting that considers all building and user needs. Particular attention is to be paid to pedestrian areas, barrier free travel paths, driveways, transit stops, parking, service areas and buildings.*
- C. *Feature lighting is encouraged to high-light building relief, landscape features, and monuments.*
- D. *Use of full "cut-off" light fixtures for exterior parking lot lighting and fully shielded fixtures for wall mounted exterior lighting to eliminate glare and light spillage on neighbouring*

properties and streets (see the acceptable examples below). The term “shielded” shall mean that 100% of the lumens emitted from the light fixture are projected below an imaginary horizontal plane passing through the highest point on the fixture from which light is emitted (see Illustrations Diagram).

Examples of Acceptable / Unacceptable Lighting Fixtures

Unacceptable / Discouraged

Fixtures that produce glare and light trespass

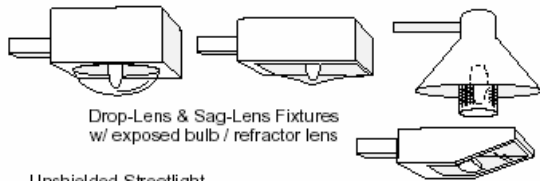
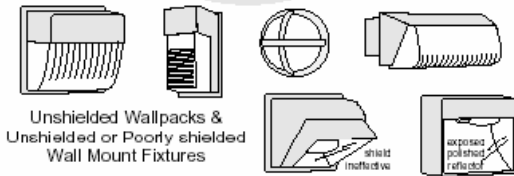
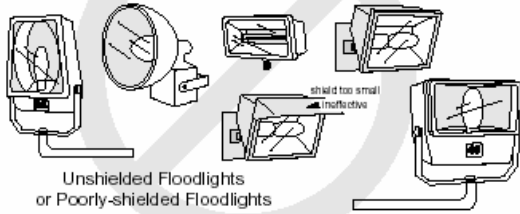

Unshielded Streetlight

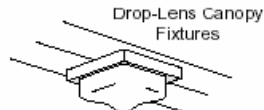
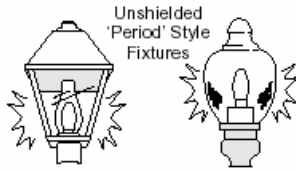
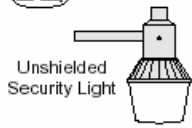

Acceptable

Fixtures that shield the light source to minimize glare and light trespass and to facilitate better vision at night

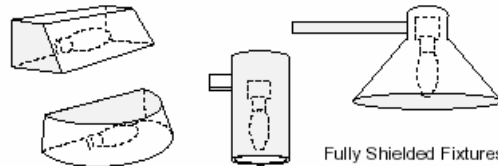
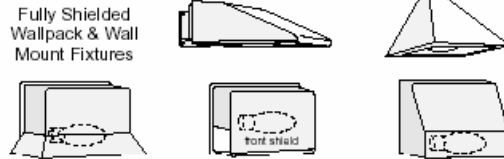
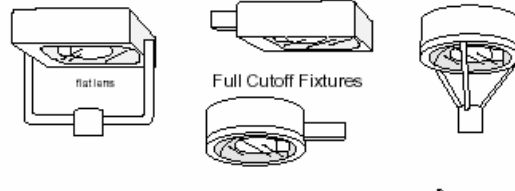

Full Cutoff Streetlight

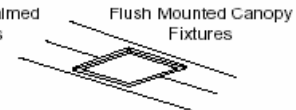
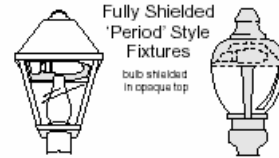
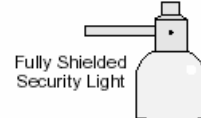

Illustrations

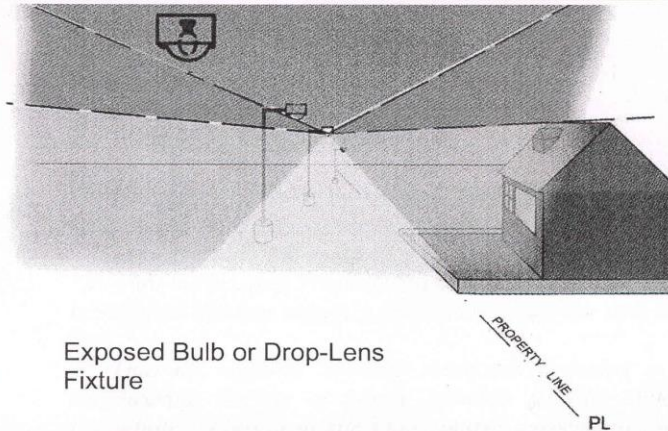

Exposed Bulb or Drop-Lens
Fixture

ILLUSTRATION A

- Does **not** deflect light away from abutting lot as required
- Emits light **above** the horizontal thereby contributing to halo of wasted light in night sky
- Glare is experienced far beyond site

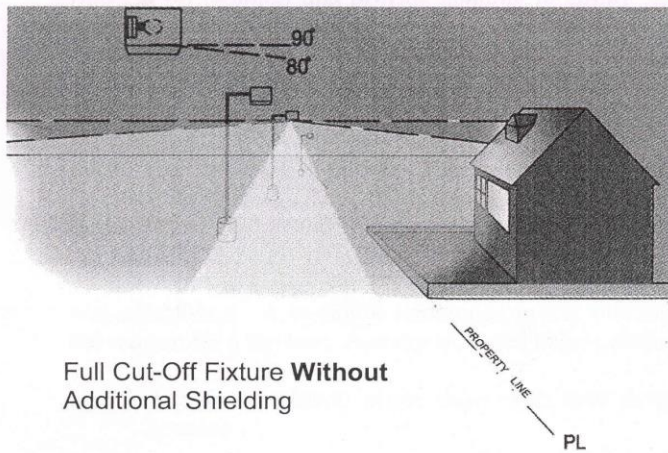

Full Cut-Off Fixture **Without**
Additional Shielding

ILLUSTRATION B

- A full cut-off fixture emits zero light intensity above 90 degrees and only 10 percent of its intensity between the 80 and 90 degree angles. The greatest intensity from a full cut-off fixture occurs in the area directly below the fixture
- Does **not** deflect light away from abutting lot as required
- Light is limited to below the horizontal

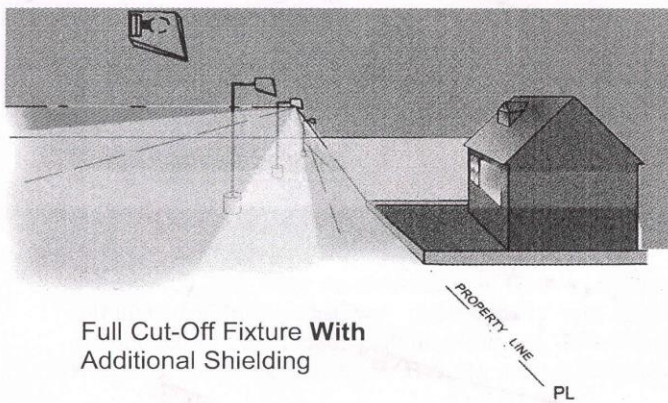

Full Cut-Off Fixture **With**
Additional Shielding

ILLUSTRATION C

- Deflects light away from neighbour's property
- Light is limited to below the horizontal
- Glare is eliminated except from specific vantage points

E. Ensure that the source of light (the element) is not visible from adjacent residential properties.

F. Use pedestrian scaled lighting (3.5 to 4 metres high) to clearly identify pedestrian routes.



A smaller scale light standards found at Heritage Park.

- G. Coordinate lighting systems and landscaping to ensure that plant materials or other landscape features do not obscure site and street lighting.*
- H. Encourage lighting areas that are intended to support evening/night activities. Avoid lighting all public areas as it creates a false sense of security for people passing through the night.*

6.0 FENCING

DESIGN GUIDELINES

- A. *Design fencing, acoustic barriers and similar site elements that are compatible with the architecture of the main buildings and use complementary materials.*
- B. *Minimize visual monotony through changes in plane, height, material or material texture, or landscape massing for acoustic barriers, masonry walls or fences that are 15 metres in length or longer and 1.3 metres in height or taller.*
- C. *Avoid walling off an entire development as it creates a fortress effect that would reduce monitoring opportunities.*



The visual impact of this fence is reduced through changes in plane and landscape massing.

DESIGN STANDARDS AND POLICIES

Acoustic 'D' Fence

1. Acoustic 'D' fencing is to be detailed and installed in a manner that conforms to or exceeds BSD-19A.

2. Fence locations and dimensions shall be in accordance with the applicable noise study and MOEE guidelines.

Reverse Lot Frontage Fencing

3. Reverse lot frontage fencing is to be detailed and installed in a manner that conforms to or exceeds BSD-19B.

Tight Board/Screen Fencing (Visual Screen)

4. Tight board/screen fencing between a commercial or industrial use and a residential use is to be detailed and installed in a manner that conforms to or exceeds BSD-19B.
5. Tight board/screen fencing between residential uses or commercial uses is to be detailed and installed in a manner that conforms to or exceeds BSD-19C.

Stormwater Facility Fencing

6. Stormwater facility fencing is to be detailed and installed in a manner that conforms to or exceeds BSD-20.

Park Fencing

7. Park fencing is to be detailed and installed in a manner that conforms to or exceeds BSD-21.

Environmentally Protected Area Fencing

8. Environmentally protected area fencing is to be detailed and installed in a manner that conforms to or exceeds BSD-21.

Rear Yard Fencing of Street Townhouses

9. A minimum 2.0m tightboard fence shall be constructed adjacent to the rear yard of any street townhouse block which abuts lands zoned detached or semi-detached residential, or which abuts lands zoned for street townhousing (refer to Diagram A).

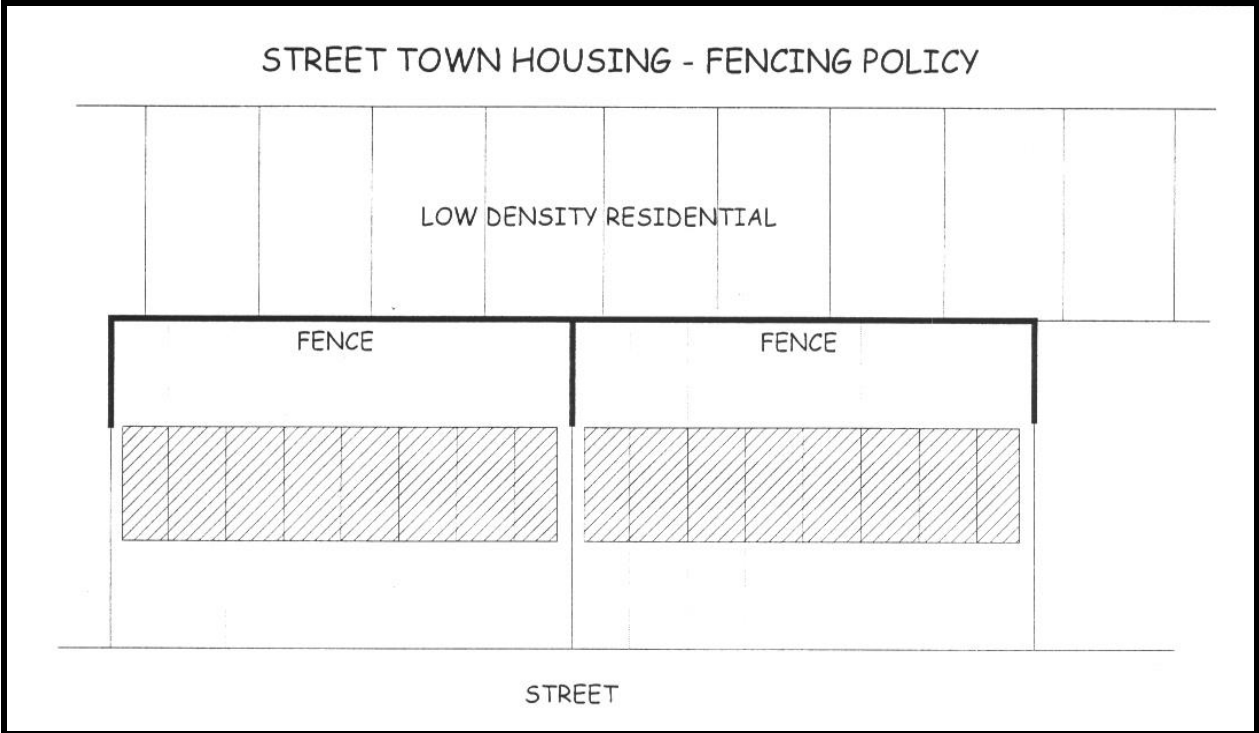

Diagram A

7.0 ARCHITECTURAL DESIGN

DESIGN GUIDELINES

- A. *Ensure that the architectural design is compatible with the developing character of the neighbouring area. Design compatibility includes complementary building style, form size, colour and materials. Ensure that building heights and scale relate to the existing developed form of the area and unify or enhance the building character of the neighbourhood.*



This newer office development is consistent in design and scale with the neighbouring area.

- B. *Design multiple buildings on the same site to create a cohesive visual relationship between the buildings.*
- C. *Coordinate exterior building design and detail on all elevations with regard to colour, types of materials, number of materials, architectural form, and detailing to achieve harmony and continuity of design.*
- D. *Locate the main building facade towards a public street or internal courtyard. Principle walls should have windows along the street or interior space to provide casual surveillance and break up the building mass. Where blank walls are unavoidable, use architectural techniques (banding, soldier course, etc.), landscaping, and murals to enhance the elevation.*



Colour variation and landscaping help to enhance this elevation.

- E. Enclose or screen rooftop mechanical equipment. Integrate roofs and screening with the design of the building in terms of form, materials and colour.*
- F. Ensure that buildings over 3 storeys in the City Centre contribute to the skyline and all roof top penthouses and equipment is screened in a distinctive manner (e.g. in the form of an angled rooftop design).*
- G. Design rooftops to have some identifiable shape. Avoid square or flattops on large buildings.*



The roof design of this apartment building encloses the roof top equipment and provides an identifiable shape to the structure.

H. Ensure that main entrances to buildings are prominent and identifiable from the street to encourage pedestrian use.



A well defined entrance and walkway connection to the municipal sidewalk encourages use by pedestrians.

- I. *Effective use of building materials, architectural details and lighting is encouraged.*
- J. *Ensure that buildings situated on corner lots have presence on both streets.*



The siting of this building provides a strong central focus and exposure on both streets.

- K. *Buildings should be strategically designed to minimize alcoves or hiding spots for offenders to hide in.*
- L. *Buildings should naturally direct visitors toward the main entry point where it is observable by residents and security.*
- M. *Balcony space should be large enough to provide a useable activity area for residents, thereby increasing opportunities for residents to overlook public areas. Balcony railings should be built with transparent or open metal material as it will increase surveillance opportunities.*
- N. *Access points to buildings should be reduced so as to be manageable for security officers.*
- O. *Define entrances to the site and each parking lot with landscaping, architectural design, or symbolic gateways.*

7.1 Building Façades in the Downtown Barrie BIA

DESIGN GUIDELINES

These guidelines were prepared for use in guiding the future façade development of properties in the Downtown Barrie Area. The area of interest includes all properties located within the Business Improvement Area (BIA) boundaries, with emphasis on Dunlop Street East and West. The guidelines are intended to provide a unified approach to improving and standardizing development from a visual point of view.

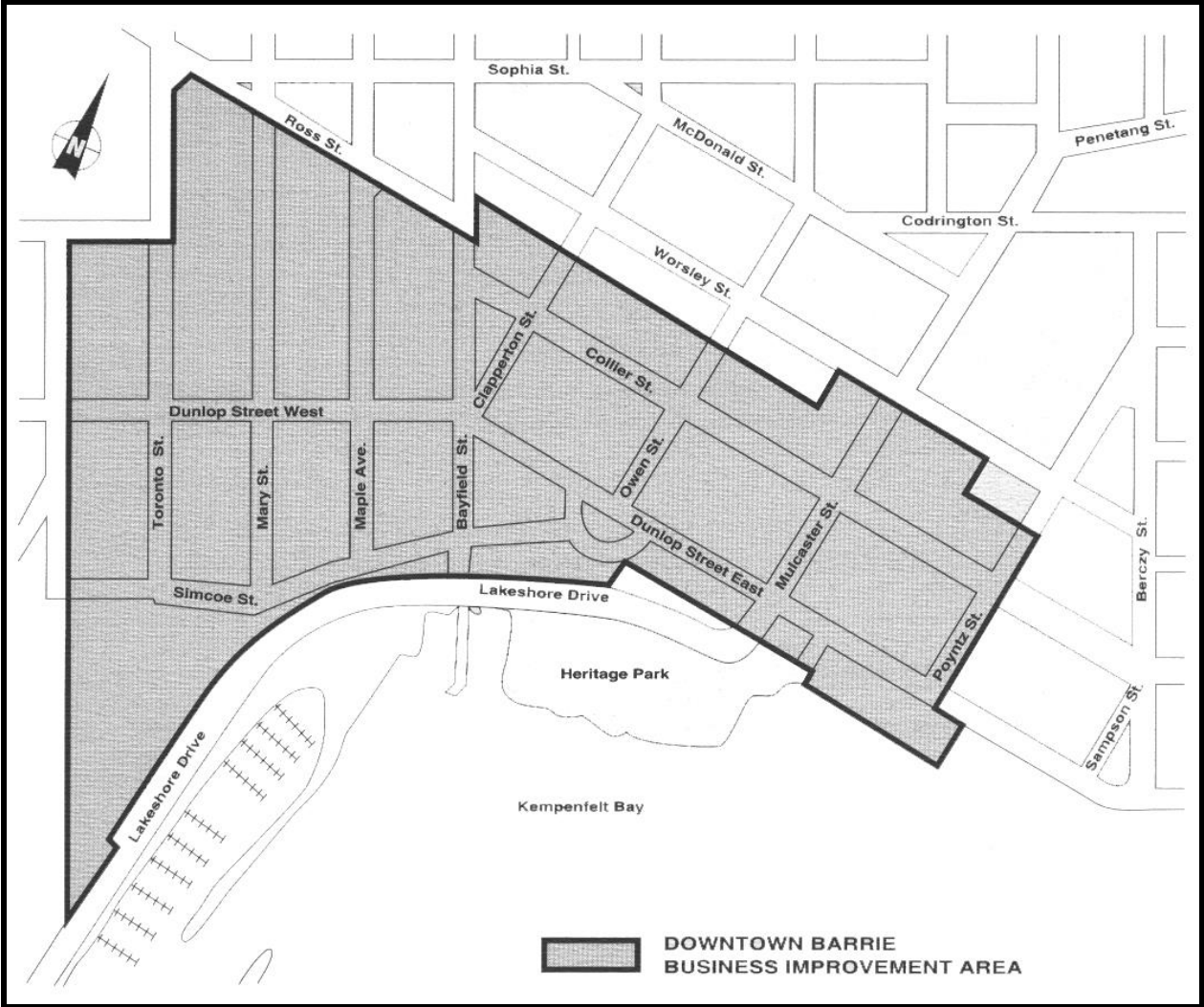

City of Barrie Business Improvement Area

1. Context of Façade

Dunlop Street, which is the focus of these guidelines, extends east and west from the intersection of Bayfield, Clapperton and Dunlop, commonly called “the five points”. Heritage Barrie has identified the façades on Dunlop Street East as representative of the Victorian style; and as built in the 1880’s and 1890’s, with some earlier expectations. The style of the façades on Dunlop Street West is Post-Victorian, being constructed from the turn of the century up to the 1950’s with some exceptions. The following general principles apply depending on where the façade is located.

- a) Original architecture details should be incorporated to enhance the façade while preserving the style of the period in which the building was constructed.*
- b) If there is not sufficient, significant architectural detail, a treatment that incorporates details representative of the style of the period in which the building was constructed should be encouraged.*
- c) If a building and/or façade is to be built where no building exists, the new façade should be sympathetic to the style of the adjacent structures where that style is architecturally significant.*
- d) Where the adjacent structures have no architecturally significant detail, the design of a new building façade should be compatible in height and mass.*

2. Treatments

The treatments of individual façades may be done using the following guide:

- a) Where historic details are in evidence, they should be enhanced. This is perhaps the easiest façade to deal with since repair work may be all that is needed.*

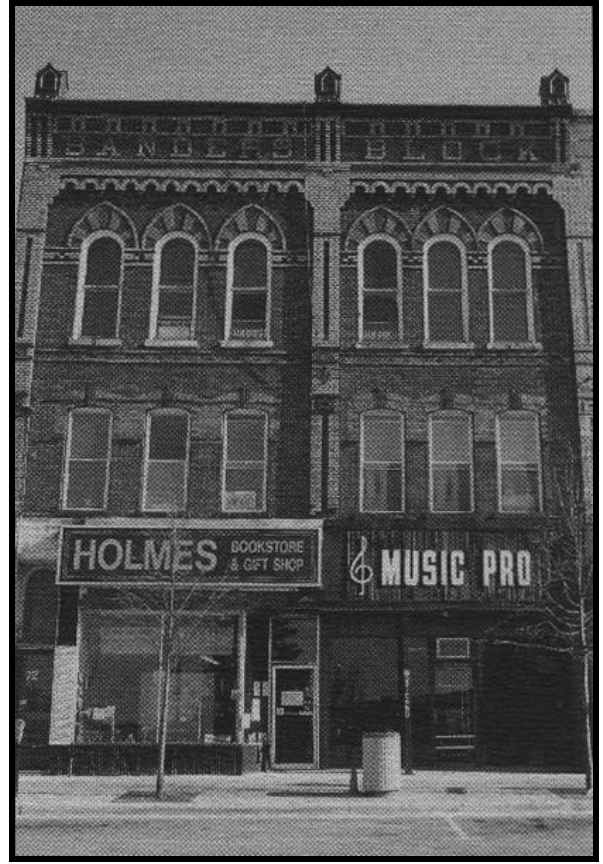
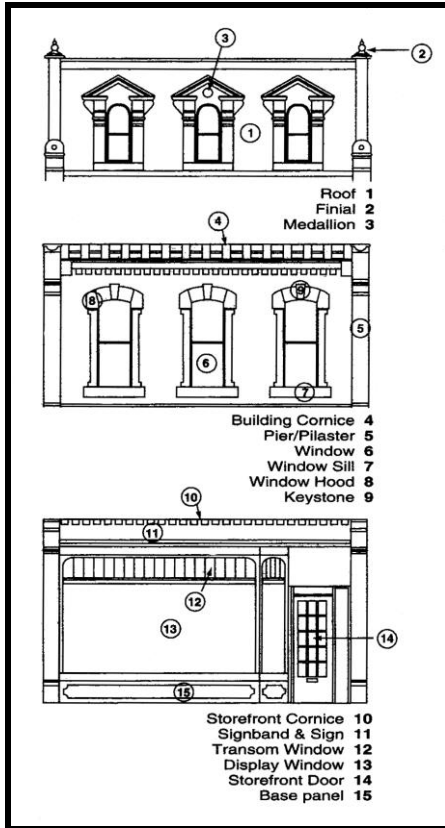

- b) *There has been a tendency in the past decade to cover over heritage façades with maintenance free siding. Although this may be cost effective, the character of the building is sacrificed and if all façades are treated this way the character of Dunlop Street may be lost. These guidelines strongly recommend the avoidance of siding or other non-traditional building materials. Where siding has been installed, the municipality encourages owners to research the history of their building to determine if there is a hidden heritage façade worthy of restoration.*

- c) *Where a façade is part of a redesigned building or where the original heritage features have been removed, these original features can be successfully incorporated in a new façade which maintains a balance with adjacent buildings.*

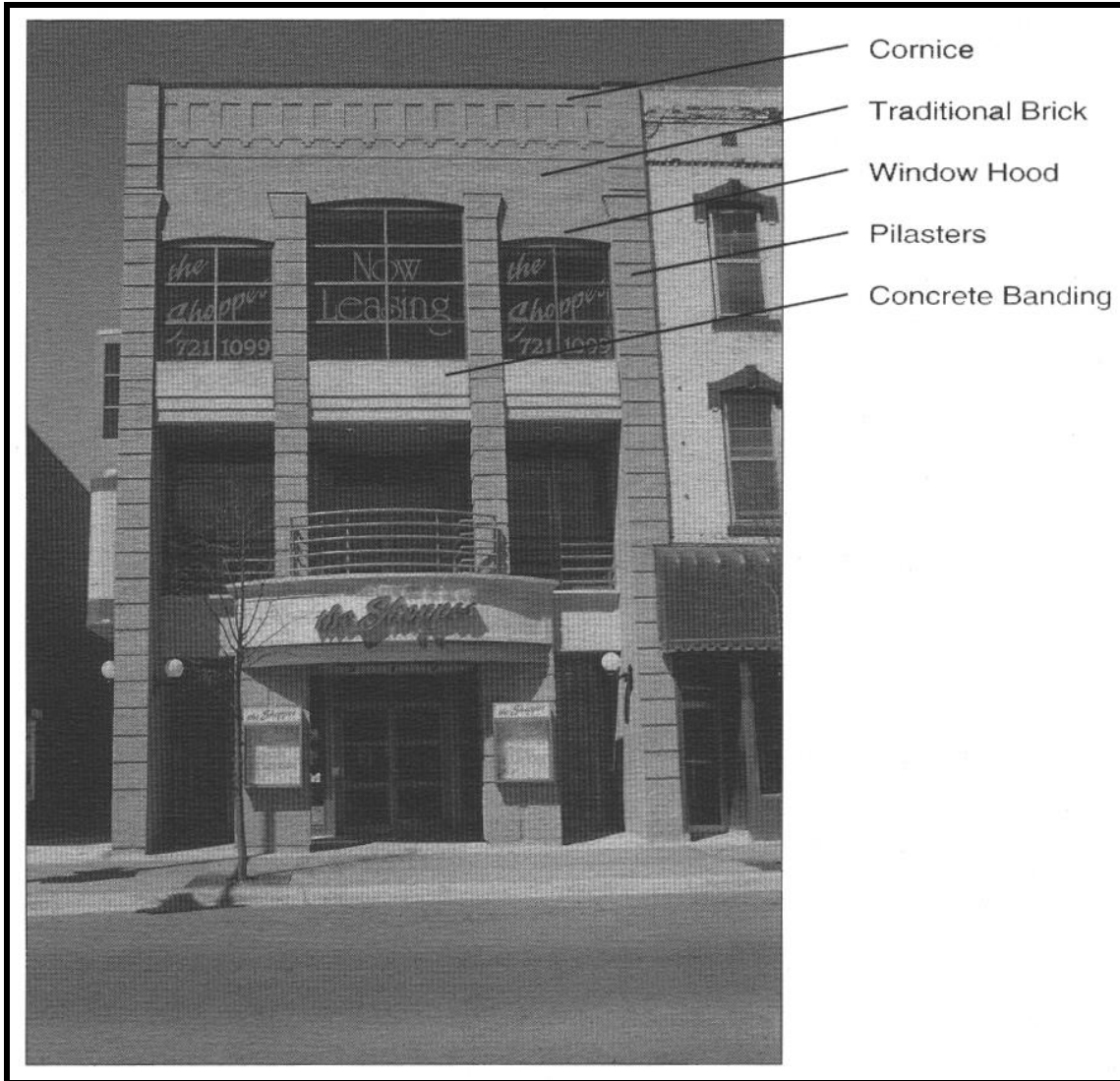

- d) *The term heritage is sometimes confused with old. A building's façade does not have to be old to be a worthwhile preservation project. Heritage façades 75 years from now may include those built in this century or, for that matter, this decade. Good design is always worthy of preservation and enhancement.*



- e) *There are a few vacant lots on Dunlop Street. What is built on them can be either a challenge to the character of the streetscape or a complement. The City of Barrie supports and encourages a high level of urban design for private development. The site plan control process is intended to examine applications for major developments. When new buildings are to be constructed, these guidelines will be utilized when considering the appropriateness of a new façade.*

3. The Storefront

The most dynamic part of a commercial façade is the street level storefront or business entrance. In many cases signage is a strong element. Most downtowns have seen

dramatic changes in this area over the past 100 years. Products and services have changes and displaying these has become increasingly sophisticated. In almost every modern shopping mall the storefront is almost transparent. In the downtown, each storefront carries an identity. Familiar names and faces are associated with “signature” storefronts. The stronger the signature or identity, the stronger the downtown character will remain.

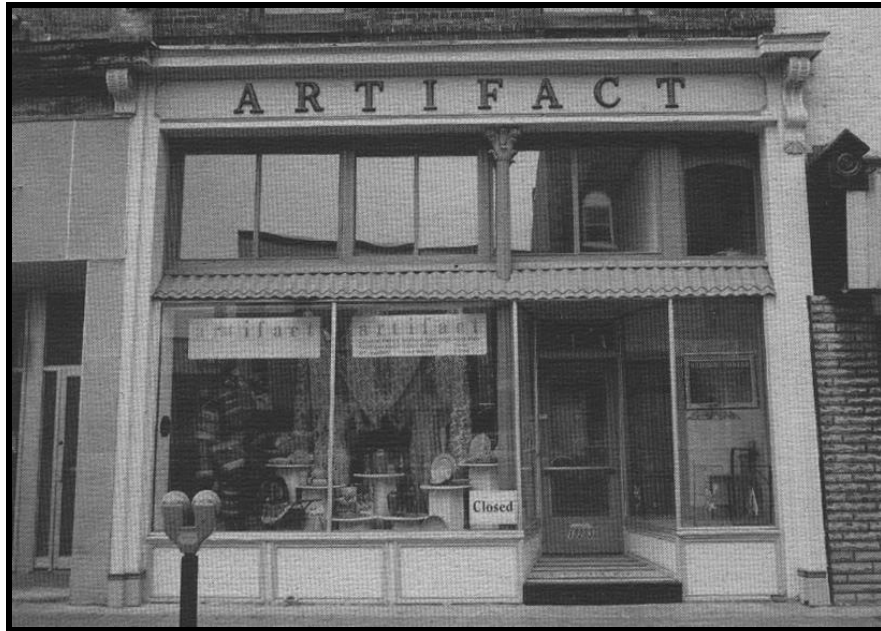

4. Treatments

- a) *Where an existing storefront is physically sound and compatible with overall building façade through its design, details and proportions; maintain and repair it rather than replace it. Remove additions attached in front of or outside of the storefront (including fluorescent sign boxes along fascia), unless these are actual originals or restorations based on early historic photographs.*



- b) *Where an existing storefront does not fit with the historic character of the building, consider replacing it by revealing the earlier front beneath (if recoverable), by installing a more fitting modern design, or by restoring (with proper research and documentation) an authentic earlier appearance. Consider any storefront replaceable that covers over historic material with bland or poorly fitting materials and features of no intrinsic merit, or that encroaches into the street beyond the historic edges of the building, or that is profoundly dissonant when seen in context with its neighbours, so long as the overall façade is not damaged or devalued.*
- c) *Where the physical condition of a storefront (either existing or concealed) is too poor to repair without massive replacement and where it is considered appropriate to recover a genuine earlier appearance, restore that appearance using existing materials, building archeology and archival photographs, with as little conjecture as possible. Use firm evidence to reproduce an earlier front rather than conjectural evidence about the actual original. Use surviving materials as models for colour and detail, reproducing in kind as much as possible.*

5. Wall Murals

The use of murals can be an effective tool in attracting not only tourists, but also local citizens to the downtown. The City of Barrie endorses wall murals that incorporate content related to the cultural and historical backgrounds of the community.



7.2 Heritage Resources

DESIGN GUIDELINES

- A. Ensure that new development complements and, where possible, incorporates heritage resources of natural, historical, architectural or cultural significance.
- B. Conserve significant heritage resources including buildings and structures using strategies such as:
 - Preservation – maintaining and/or restoring a heritage resource within its context of setting.
 - Adaptive re-use – rehabilitation of a heritage resource for a new use.

- *Incorporation - integration of individual components of a heritage resource into new development.*



This old church has been rehabilitated to an office use while retaining its key heritage features.



This historic armoury building has been rehabilitated to accommodate office space.

- C. Identify significant architectural details and features of heritage resources and incorporate similar details and features into new building designs.*
- D. Ensure that the design and location of lighting, streets, signage, parking, public works facilities, grading and other site features respect the integrity and character of the heritage resource.*

8.0 SIGNAGE

DESIGN GUIDELINES

- A. *Architecturally integrate all signs with their surroundings in terms of size, shape, colour, texture and lighting so that they are complementary to the overall design of the building and are not in visual competition with other signs in the area.*
- B. *Construct ground signs that incorporate building and landscape materials used elsewhere in the project.*



A well designed ground sign that incorporates materials used on the building.

- C. *Ensure that new signs proposed for existing buildings provide a compatible appearance with building signage of other tenants. With multiple signs on a single building, attempts to bring in a unifying element such as size.*
- D. *Provide a uniform height and location of fascia signs on multiple tenancy buildings in order to portray a unified image.*



The fascia signs are uniform in height and location.

- E. Ensure that new construction design anticipates signage by providing logical sign areas, allowing flexibility for new users as the building is re-tenanted over time. Designs that provide for convenient and attractive replacement of signs are encouraged.*
- F. Provide appropriate landscaped areas on the site to properly identify the location of mobile signs.*
- G. Ensure that mature landscaping and signage work in harmony with each other.*



Appropriate landscaping complements this ground sign.

H. Provide approved address numbers so that they are legible to the public from the street fronting the property.



The street address is prominently displayed.

DESIGN STANDARDS AND POLICIES

1. All signage shall comply with City of Barrie Sign By-law 2005-93 as amended and the Ontario Building Code.
2. The following signs are prohibited.
 - Signs erected in part or entirely above the surface of the roof of a building or structure are prohibited, with the exception of a wall sign attached to a parapet wall of cupola that may extend above the roof line.
 - Signs which, by reason of size, location, or illumination, obstruct the vision of drivers or pedestrians, or obstruct or detract from the visibility or effectiveness of any traffic sign or control device on public streets and roads or which are located in a daylighting triangle.
 - Signs located so as to obstruct or impede any required fire escape, fire exit, door, window etc., or so to prevent or impede access of firefighters to any part of a building.
3. The maximum height of a ground sign is 7.5 metres measured from the finished level at the base of the supporting structure.
4. Every ground sign shall be set back a minimum of:
 - 1.0 metre from any street line;
 - 1.5 metres from any common lot boundary with an adjacent lot;
 - 1.5 metres from any driveway, aisle or walkway or parking space;
 - 1.5 metres from any other ground sign located on the same side of the street;
 - 6.0 metres from the common lot boundary where an adjacent lot contains a residential use; and
 - 3.0 metres from all overhead electrical distribution facilities.
5. No ground sign is permitted within a daylighting triangle of a corner lot.
6. Ground signs shall include soft landscape treatment at the base of the sign or supporting structure. The boundaries of the landscaped area are defined by a line measuring a minimum of 1.0 metre from all sides of the sign or supporting structure.

7. All development on lands zoned Commercial, Industrial and Institutional shall designate an area or areas, where applicable, on site for the placement of a mobile sign. Every mobile sign shall be located entirely on private property and shall be set back a minimum of:
- 15.0 metres from any other mobile sign located on the same or adjacent lot;
 - 1.5 metres from a driveway, aisle, walkway or parking space;
 - 1.0 metre from the street line;
 - 1.5 metres from any common lot boundary with an adjacent lot;
 - 1.5 metres from any permanent sign; and
 - shall not be located in a daylighting triangle or planting bed.

9.0 LANDSCAPE DESIGN

DESIGN GUIDELINES

- A. *Promote the preservation of existing natural features such as watercourses, specimen trees, hedgerow and woodlot vegetation wherever reasonably possible in an effort to minimize the environmental impact on the site and surrounding areas.*



The retention of existing vegetation helps integrate this new school into an established and mature neighborhood.

- B. *Promote an attractive landscape treatment of the site to soften and improve the visual character of the development by designing a harmonious integration of planting, fencing, retaining walls, hard surfaces, signage, etc.*



A good example of a harmonious integration of plantings, retaining walls and hard surfaces.

C. Ensure appropriate plant species are proposed in relation to availability, cold hardiness, mature size and habit, sunlight/soil requirements, moisture/drought tolerance, pollution/salt tolerance, and seasonal effects.

D. Provide traffic islands to delineate primary vehicular traffic routes.



The primary vehicular traffic route is clearly delineated by landscaped traffic islands.

- E. *Ensure soft landscape areas on the perimeters of the site to delineate boundaries, and establish streetscape appeal, spatial separations, berming and snow storage areas.*
- F. *Strategic landscape screening and/or fencing is encouraged for exposed parking, driveways, storage, services and garbage containment areas.*



The variety of plantings is used to screen this parking area from the street.

- G. *Design landscaping to encourage positive functional relationships between the site uses and their surroundings in order to avoid conflicts, and/or require effective levels of buffering and fencing to minimize those conflicts. Relate landscape treatment of soft areas to their specific function, such as streetscaping, buffering, erosion control and energy conservation (windbreaks/shading).*
- H. *Landscape areas outside the building entrance(s) including barrier free hard surfaces (other than asphalt) to clearly define its function.*
- I. *Provide additional soft landscape areas within the site and foundation planting to reduce the negative impact of continuous expanses of pavement, to help delineate vehicular and pedestrian circulation, and provide opportunities to layer the landscaping between the street and building in relation to façade design.*
- J. *Where appropriate, include the provision of appropriate site amenities and furnishings (i.e. C.S.A. approved playscapes, patios, benches, etc.).*



This office development includes outdoor amenities that complement the landscaping features.

- K. Tree preservation is promoted through the City of Barrie Tree Cutting By-law 2002-12 and the issuance of tree cutting permits. In situations where the by-law does not apply, it is the intent of these Guidelines that healthy trees be preserved whenever possible, and that no tree removal occur until the site plan is approved.*

- L. The following lists are intended to offer a generally acceptable selection of plant species commercially available and suitable for the local climate. It is not intended to limit the design choices of Landscape Consultants.*

Plant Categories Index

- 1. Large Deciduous Trees*
- 2. Small Deciduous Trees*
- 3. Large Deciduous Shrubs*
- 4. Small Deciduous Shrubs*
- 5. Large Coniferous Trees*
- 6. Small Coniferous Trees/Large Evergreen Shrubs*
- 7. Small Evergreen Shrubs*
- 8. Vines*

Plant Characteristics Index

The various characteristics of each species are denoted by codes from the following legend:

Native Species:	N – native
Shape:	R – round U – upright/arching vase W – weeping P – pyramidal S – spreading I – irregular O – oval C – columnar
Hardiness:	CH – cold hardy CWX – cold/wind sensitive
Growth Rate:	FS – fast SL – slow
Soil Tolerance:	SD – sand CL – clay
Moisture Tolerance:	WT – wet DR – dry
Solar Tolerance:	SH – shade tolerant SU – full sun
Salt Tolerance:	SA – salt tolerant SAX – salt sensitive
Pollution Tolerance:	PU – pollution tolerant PUX – pollution sensitive
Erosion Control:	SS – slope stabilizing
Good Fall Colour:	FC
Good Flowering:	GF
Notable Fruiting:	NF

1. Large Deciduous Trees

- *Acer X Freemanii* (Autumn Blaze Maple) O / FS / FC
- *Acer X Free “Armstrong”* (Armstrong Maple) U / FS / FC
- *Acer Platanoides* (Norway Maple) R / CH / DR / SA / PU
- *Acer Platanoides “Crimson King”* (Crimson King Maple) R / CH / DR / SA / PU
- *Acer Platanoides “Deborah”* (Deborah Maple) R / CH / DR / SA / PU
- *Acer Platanoides “Emerald Queen”* (Emerald Queen Maple) O / CH / DR / SA / PU
- *Acer Platanoides “Royal Red”* (Royal Red Maple) O / CH / DR / SA / PU
- *Acer Platanoides “Superform”* (Superform Maple) O / CH / DR / SA / PU

- *Acer Rubrum* (Red Maple) N / R / CH / FS / CL / WT / SAX / PUX / FC
- *Acer Saccharinum* (Silver Maple) N / U / CH / FS / CL / WT / SU
- *Acer Saccharum* (Sugar Maple) N / O / CH / SL / SH / SAX / PUX / FC
- *Aesculus Hippocastanum* (Common Horsechestnut) O / CH / SH / SA / PU / NF
- *Betula Payrifera* (White Birch) N / P / CH / FS / SD / SU / PUX / FC
- *Catalpa Speciosa* (Northern Catalpa) O / FS / SD / DR / NF / PU
- *Celtis Occidentalis* (Common Hackberry) N / U / CH / FS / SD / DR / SU / PU / FC
- *Cercidiphyllum Japonicum* (Katsura Tree) P / FS / WT / SU / FC
- *Corylus Colurna* (Turkish Hazel) P / SD / DR / SU / PU
- *Fagus Grandfolia* (American Beech) N / R / CH / SL / SH
- *Fagus Sylvatica* "Purpurea" (Purple European Beech) P / SL / SH
- *Fagus Sylvatica* "Fastigiata" (Pyramidal Beech) C / CH / SL / SH
- *Fraxinus Americana* (White Ash) N / O / DR / SU / SA / FC
- *Fraxinus Pennsylvanica* "Patmore" (Patmore Green Ash) N / O / CH / FS / CL / SU / SA / PU
- *Fraxinus Pennsylvanica* "Summit" (Summit Green Ash) N / P / CH / FS / CL / SU / SA / PU
- *Ginkgo Biloba* (Maidenhair Tree) P / SL / SD / WT / SU / SA / PU / FC
- *Ginkgo Biloba* "Princeton Sentry" (Princeton Sentry Ginkgo) C / SL / SD / WT / SU / SA / PU / FC
- *Glenditsia Tricanthos* "Shademaster" (Shademaster Honeylocust) U / FS / DR / SU / SA / PU
- *Glenditsia Tricanthos* "Skyline" (Skyline Honeylocust) P / FS / DR / SU / SA / PU
- *Glenditsia Tricanthos* "Sunburst" (Sunburst Honeylocust) P / FS / DR / SU / SA / PU
- *Gymnocladus Dioicus* (Kentucky Coffee Tree) I / SL / DR / SU / PU
- *Juglans Nigra* (Black Walnut) N / O / CH / SL / CL / SU / NF / FC
- *Liriodendron Tulipifera* (Tulip Tree) N / P / CWX / FS / WT / SU / FC / GF
- *Phellodendron Amurense* (Amur Cork Tree) V / CH / DR / SU / PU
- *Platanus Occidentalis* (American Plane Tree) N / I / FS / WT / SU
- *Quercus Palustris* (Pin Oak) P / SL / CL / WT / SU / PU / FC
- *Quercus Robur* "Fastigiata" (Pyramidal English Oak) C / SL / SU
- *Quercus Rubra* (Red Oak) N / R / CH / SL / SD / DR / SU / SA / PU / FC
- *Salix Alba* "Tristis" (Golden Weeping Willow) W / CH / FS / WT / CL / SU

2. Small Deciduous Trees

- *Acer Campestre* (Hedge Maple) R / SL / DR / PU
- *Acer Ginnala* (Amur Maple) R / CH / FS / SH / FC
- *Acer Palmatum* (Japanese Maple) S / CWX / SL / SH / FC
- *Acer Palmatum* "Bloodgood" (Bloodgood Japanese Maple) S / CWX / SL / SH
- *Acer Platanoides* "Columnar" (Columnar Maple) C / CH / DR / SA / PU
- *Acer Platanoides* "Crimson Sentry" (Crimson Sentry Maple) P / CH / DR / SA / PU
- *Acer Platanoides* "Drummondii" (Harlequin Maple) O / CWX / DR / SA / PU
- *Acer Platanoides* "Globosum" (Globe Maple) R / CH / DR / SA / PU
- *Amelanchier Canadensis* (Shadblow Serviceberry) N / U / CH / WT / SH / FC / GF
- *Betula Pendula* "Youngii" (Young Weeping Birch) W / CH / FS / SU / PUX
- *Caragana Arborescens* "Pendula" (Weeping Siberian Peashrub) W / CH / FS / DR / SU / SA / GF
- *Cercis Canadensis* (Eastern Redbud) N / I / CWX / GF / FC
- *Cornus Alternifolia* (Alternate-Leaf Dogwood) N / S / CH / SH / NF
- *Crataegus X Mordenensis* "Snowbird" (Snowbird Hawthorn) I / CH / SL / DR / SU / PU / GF / NF
- *Elaeagnus Angustifolia* (Russian Olive) I / CH / FS / SD / DR / SU / SA / PU
- *Magnolia X Soulangeana* (Saucer Magnolia) U / CWX / WT / SU / GF
- *Malus* Var. (Crabapples) I / CH / CL / SU / GF / NF
- *Prunus Virginiana* "Shubert" (Shubert Chokecherry) P / CH / FS / GF / NF
- *Pyrus Calleryana* "Bradford" (Bradford Pear) P / CWX / FS / DR / SU / PU / GF / NF / FC
- *Pyrus Calleryana* "Chanticleer" (Chanticleer Pear) P / CWX / FS / DR / SU / PU / GF / NF / FC

- *Rhus Typhina* (Staghorn Sumac) N / I / CH / FS / DR / SD / SU / SA / PU / SS / FC / NF
- *Sorbus Aucuparia* "Fastigiata" (Pyramidal Mountain Ash) C / CH / SL / NF / GF / FC
- *Syringa Reticulata* "Ivory Silk" (Ivory Silk Tree Lilac) O / CH / SU / GF
- *Tilia Cordata* "Glenleven" (Glenlevel Linden) P / CH / FS / SU / PU / FC
- *Tilia Cordata* "Greenspire" (Greenspire Linden) P / CH / FS / SU / PU / FC
- *Ulmus Glabra* "Camperdownii" (Camperdown Elm) I / CH / WT / SU / SA
- *Viburnum Lantana* (Wayfaring Tree) U / CH / DR / SH / NF / GF
- *Viburnum Lentago* (Nannyberry) N / U / CH / WT / SH / NF / GF

3. Large Deciduous Shrubs

- *Acanthopanax Sieboldianus* (Fiveleaf Aralia) U / FS / SD / DR / SH / PU
- *Caragana Arborens* (Siberian Peashrub) U / CH / FS / DR / SU / SA / GF
- *Cornus Alba* "Elegantissima" (Silveredge Dogwood) U / CH / FS / WT / SU / SAX
- *Cornus Sericea* (Red Osier Dogwood) N / R / CH / FS / WT / SAX / SS
- *Cornus Sericea* 'Flaviramea' (Yellowtwig Dogwood) N / R / CH / FS / WT / SU / SAX
- *Corylus Avellana* "Contorta" (Corkscrew Hazel) I / FS / SU
- *Cotinus Coggygia* "Royal Purple" (Royal Purple Smoke Bush) I / SD / DR / SU
- *Cotoneaster Acutifolius* (Peking Cotoneaster) O / CH / SD / DR / SU / SA
- *Euonymus Alatus* (Winged Burningbush) R / CH / SL / SH / FC / NF
- *Forsythia Ovata* "Northern Gold" (Northern Gold Forsythia) R / CH / SU / PU / GF
- *Hamamelis Virginiana* (Witch Hazel) N / I / WT / SH / FC / PU
- *Hydrangea Paniculata* "Grandiflora" (Peegee Hydrangea) U / FS / SH / PU / GF
- *Kerria Japonica* "Pleniflora" (Double Flowering Kerria) U / FS / SH / GF
- *Kolkwitzia Amabilis* (Beauty Bush) U / FS / SU / GF
- *Ligustrum Amurense* (Amur Privet) U / FS / DR / SH / PU
- *Lonicera Tatarica* "Arnold Red" (Arnold Red Honeysuckle) U / CH / FS / SH / GF / NF
- *Philadelphus Coronarius* "Aureus" (Golden Mockorange) R / FS / SU / GF
- *Prunus X Cistena* (Purpleleaf Sandcherry) U / CH / FS / GF
- *Prunus Triloba* var. *Multiplex* (Double Flowering Almond) U / CWX / GF
- *Salix Purpurea* "Nana" (Blue Arctic Willow) R / CH / FS / WT / SU / SS
- *Sambucus Canadensis* (American Elderberry) N / U / CH / FS / WT / NF
- *Spiraea X Vanhouttei* (Bridalwreath Spirea) R / CH / FS / GF
- *Syringa* var. (Lilac) U / CH / SU / GF
- *Viburnum Trilobum* (American Cranberrybush Viburnum) N / CH / WT / SH / GF / NF

4. Small Deciduous Shrubs

- *Chaenomeles Japonica* (Japanese Quince) S / DR / GF / NF
- *Deutzia Gracilis* (Slender Deutzia) M / SL / SU / GF
- *Euonymus Alata* 'Compacta' (Dwarf Burningbush) R / CH / SL / SH / FC / NF
- *Hydrangea Arborescens* 'Annabelle' (Annabelle Hydrangea) R / FS / SH / NF
- *Physocarpus Opulifolius* 'Dart's Gold' (Dart's Gold Ninebank) U / CH / FS / DR / SU
- *Potentilla Fruiticosa* (Bush Cinquefoil) R / CH / SL / DR / SU / GF
- *Rhus Aromatica* (Fragrant Sumac) N / S / CH / SL / DR / SD / SU / SS / FC
- *Ribes Alpinum* (Alpine Current) R / CH / SH
- *Rosa Rugosa* (Rugosa Rose) R / CH / FS / DR / SD / SU / SA / PU / SS / GF / NF
- *Sorbaria Sorbifolia* (False Spirea) U / CH / FS / WT / SH / SS
- *Spiraea Bumalda* (Spirea) R / CH / FS / GF / SS
- *Symphoricarpos Alba* (Snowberry) N / R / CH / FS / CL / WT / SH / SS / NF
- *Symphoricarpos Chenaulti* 'Hancock' (Hancock Coralberry) S / CWX / FS / SS / NF
- *Syringa Meyer* (Dwarf Lilac) R / CH / SL / SU / GF

- *Viburnum Opulus* 'Nanum' (Hedge Viburnum) R / CH / SH
- *Weigela Florida* 'Variegata' (Variegated Weigela) R / DR / SU / PU / GF

5. Large Coniferous Trees

- *Abies Balsamea* (Balsam Fir) N / P / CH / SL / WT / SH / PUX
- *Abies Concolor* (White Fir) P / CH / SL / DR / SU / PU
- *Abies Fraseri* (Fraser Fir) N / P / CH
- *Larix Decidua* (Common Larch) N / P / CH / FS / WT / SU / PUX / FC
- *Picea Abies* (Norway Spruce) P / CH / FS / CL / SU
- *Picea Glauca* (White Spruce) N / P / CH / WT / SH
- *Picea Omorika* (Serbian Spruce) P / CWX / SL / SU / PU
- *Picea Pungens* (Colorado Spruce) P / CH / DR / SU / SA / PU
- *Picea Pungens* "Glauca" (Colorado Blue Spruce) P / CH / DR / SU / SA / PU
- *Pinus Nigra* (Austrian Pine) P / FS / SD / DR / SU / SA / PU
- *Pinus Resinosa* (Red Pine) N / P / CH / SD / DR / SU / SAX
- *Pinus Strobus* (Eastern White Pine) N / P / CWX / FS / SD / SU / SAX / PUX
- *Pinus Sylvestris* (Scot's Pine) I / CH / FS / SD / DR / SU / SAX
- *Pseudotsuga Menziesii* (Douglas Fir) P / CWX / SU
- *Thuja Occidentalis* (Eastern White Cedar) N / P / CH / SL / CL / WT / SU / SAX
- *Tsuga Canadensis* (Canadian Hemlock) N / P / CWX / SL / SH / SAX / PUX

6. Small Coniferous Trees / Large Evergreen Shrubs

- *Chamaecyparis Nootkatensis* "Pendula" (Weeping Nootka False Cypress) P / CWX / SU / PU
- *Juniperus Scopulorum* "Moffetii" (Moffet Blue Juniper) P / CH / SL / DR / SD / SU / SA / PU
- *Juniperus Scopulorum* "Wichita Blue" (Wichita Blue Juniper) P / CH / SL / DR / SD / SU / SA / PU
- *Juniperus Scopulorum* "Skyrocket" (Skyrocket Juniper) C / CH / SL / DR / SD / SU / SA / PU
- *Picea Abies* "Ohlendorffii" (Ohlendorf Spruce) P / CH / FS / CL
- *Picea Abies* "Pendula" (Weeping Norway Spruce) W / CH / FS / CL
- *Picea Glauca* "Conica" (Dwarf Alberta Spruce) N / P / CWX / SL / SAX / PUX
- *Picea Pungens* "Fat Albert" (Fat Albert Spruce) P / CH / DR / SU / SA / PU
- *Picea Pungens* "Hoopsii" (Hoopsi Blue Spruce) P / CH / DR / SU / SA / PU
- *Picea Pungens* "Kosteri" (Koster's Blue Spruce) P / CH / DR / SU / SA / PU
- *Pinus Cembra* (Swiss Stone Pine) C / SL / DR / SU
- *Pinus Strobus* "Pendula" (Weeping White Pine) N / W / CH / FS / SD / SU / SAX / PUX
- *Pinus Sylvestris* "Fastigiata" (Pyramidal Scot's Pine) C / CH / FS / SD / DR / SU / SAX
- *Taxus Cuspidata* "Capitata" (Clipped Pyramidal Japanese Yew) P / CWX / SL / SD / SH / PU
- *Taxus X Media* "Hicksii" (Hick's Yew) U / CWX / SL / SD / SH
- *Taxus X Media* "Hillii" (Hill's Yew) U / CWX / SL / SD / SH
- *Thuja Occidentalis* "Emerald" (Emerald Cedar) P / CH / SL / CL / WT / SU / SAX
- *Thuja Occidentalis* "Fastigiata" (Pyramid Cedar) P / CH / SL / CL / WT / SU / SAX
- *Thuja Occidentalis* "Holmstrupii" (Holmstrup Cedar) P / CH / SL / CL / WT / SU / SAX
- *Thuja Occidentalis* "Techny" (Techny Cedar) P / CH / SL / CL / WT / SU / SAX
- *Tsuga Canadensis* "Pendula" (Weeping Hemlock) N / W / CWX / SL / SH / SAX / PUX

7. Small Evergreen Shrubs (includes Broadleaf Types)

- *Arctostaphylos Uva-Ursi* (Bearberry) N / S / CH / SL / SD / DR / SA / FC
- *Buxus Sempervirens* 'Green Mountain' (Green Mountain Boxwood) P / CWX / SL / SH
- *Buxus Sempervirens* 'Green Velvet' (Green Velvet Boxwood) R / CWX / SL / SH
- *Cotoneaster Dammeri* (Bearberry Cotoneaster) S / CWX / FS / DR / SU / SS

- *Euonymus Fortunei* var. *Coloratus* (*Colorata Euonymus*) S / CWX / FS / SH
- *Euonymus Fortunei* 'Emerald Gaiety' (*Emerald Gaiety Euonymus*) S / CWX / FS / SH
- *Euonymus Fortunei* 'Sarcoxie' (*Sarcoxie Euonymus*) S / CWX / FS / SH
- *Juniperus Chinensis* 'Mint Julep' (*Mint Julep Juniper*) S / DR / SD / SU
- *Juniperus Chinensis* 'Gold Coast' (*Gold Coast Juniper*) S / DR / SD / SU
- *Juniperus Horizontalis* 'Bar Harbour' (*Bar Harbour Juniper*) S / SL / DR / SU / SA / SS
- *Juniperus Horizontalis* 'Plumosa Compacta' (*Compact Andorra Juniper*) S / SL / DR / SU / SA / SS
- *Juniperus Sabina* 'Blue Danube' (*Blue Danube Juniper*) S / CH / SL / DR / SU / PU
- *Juniperus Sabina* var. *Tamariscifolia* (*Tamarix Juniper*) S / CH / SL / DR / SU / PU
- *Mahonia Aquifolium* (*Oregon Grape*) U / CWX / SL / SH / GF / NF
- *Microbiota Decussata* (*Siberian Cypress*) S / CH / SD / SU
- *Pachysandra Terminalis* (*Japanese Spurge*) S / SL / SH
- *Picea Abies* 'Nidiformis' (*Nest Spruce*) S / CH / FS / CL / SU
- *Picea Pungens* 'Glauca Globosa' (*Globe Blue Spruce*) R / CH / DR / SU / SA / PU
- *Pinus Mugo* 'Mugo' (*Dwarf Mugo Pine*) M / CH / SL / SD / DR / SU / SA
- *Taxus Cuspidata* 'Nana' (*Dwarf Japanese Yew*) S / CWX / SD / SH / PU
- *Thuja Occidentalis* 'Little Giant' (*Little Giant Globe Cedar*) R / CH / SL / WT / SU
- *Vinca Minor* (*Periwinkle*) S / FS / DR / SH / GF
- *Yucca Filamentosa* (*Adam's Needle*) U / CWX / DR / SD / GF

8. Vines

- *Campsis Radicans* (*Trumpet Vine*) S / FS / GF
- *Celastrus Scandens* (*American Bittersweet*) S / CH / FS / DR / SU / NF
- *Hedra Helix* 'Baltica' (*Baltic English Ivy*) S / CWX / FS / SH / SA
- *Hydrangea Anomala* sp. *Petiolearis* (*Climbing Hydrangea*) S / SL / SH / GF
- *Lonicera Brownii* 'Dropmore Scarlett' (*Dropmore Scarlett Honeysuckle*) S / CWX / FS / SH / GF
- *Parthenocissus Quinquefolia* (*Virginia Creeper*) S / CH / FS / SD / SH / PU / FC
- *Parthenocissus Tricuspidata* (*Boston Ivy*) S / CH / FS / SD / SH / PU / FC
- *Polygonum Aubertii* (*Silver Lace Vine*) S / FS / DR

DESIGN STANDARDS AND POLICIES

1. All proposed plant material shall conform to the Canadian Nursery Trades Association Metric Guide.
2. All shrubs shall be installed in continuous planting beds with a minimum 300 mm depth of topsoil and 150 mm depth mulch over weed barrier fabric (unless floral infill planting is proposed).
3. All areas not planted shall be sodded over 150 mm depth of topsoil.
4. Minimum plant sizes shall be as follows:
 - Deciduous Trees – 60 mm caliper
 - Small Flowering Trees – 45 mm caliper
 - Coniferous Trees – 2.0 m high

- Deciduous Shrubs – 60 to 150 cm high (depending on species)
 - Coniferous Shrubs – 30 to 60 cm spread or 30 to 150 cm high (depending on species)
5. Deciduous trees shall be planted in accordance with BSD-29.
 6. Coniferous trees shall be planted in accordance with BSD-30.
 7. Shrubs shall be planted in accordance with BSD-31.
 8. Vehicular entrances to the site should include a minimum 3 metre wide x 5 metre long landscape island on each side in addition to the landscape strips. The end of the island should be approximately 15 metres from the street curb on a local/collector road. These areas should be planted primarily to create an entry gateway effect and soften the base of signage, thereby unifying it to the site. Additional traffic islands to delineate primary vehicular routes should have a minimum width of 1.0 metre, if treated with paving stone, and a minimum width of 2.5 metres, if finished in planting (refer to Diagram B).

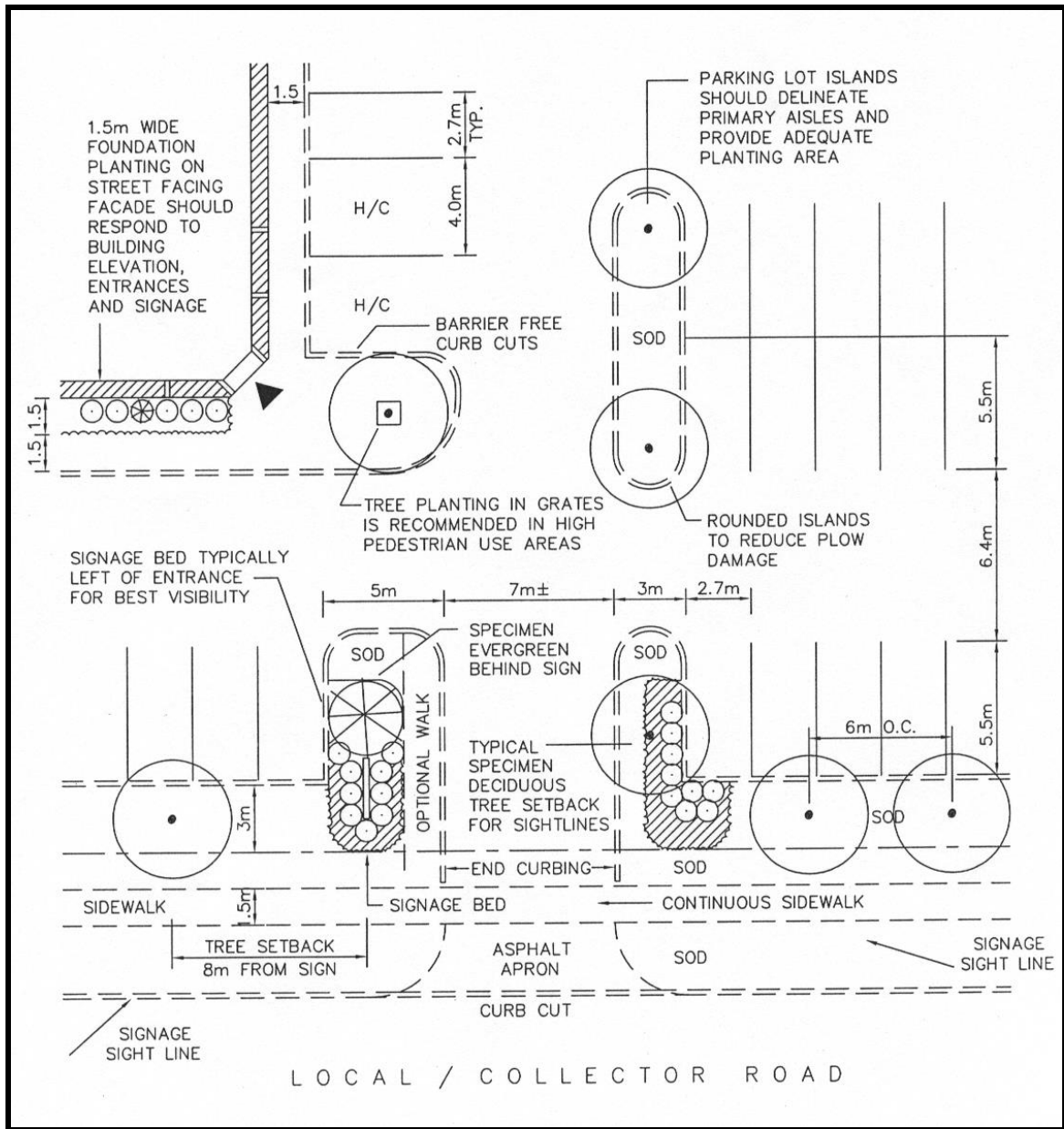

Diagram B

9. Subject to transportation requirements vehicle entrances to major collector and arterial roads which enter a parking lot deeper than 60 metres should extend vehicle entry landscaping islands to a total length of approximately 20 metres on each side and planted with deciduous trees 6 metres O.C. so as to define a vehicle stacking area. The end of the island should be approximately 30 metres from the street curb on an arterial road. These areas can also be used for walkways and accommodating grade changes. (Refer to Diagram C)

9.1 Landscape Strips

DESIGN GUIDELINES

A. *Provide landscaping strips adjacent to municipal roadways and side and rear lot lines.*



The landscape strip helps to establish streetscape appeal and an attractive spatial separation between the street and the site.

ELEMENTS SUCH AS BOULDERS, WALKS, SIGNAGE AND LIGHTING CAN BE INCORPORATED WITH PLANTING TO ENHANCE THE FUNCTION OF LANDSCAPE STRIPS AS WELL AS THEIR AESTHETICS.

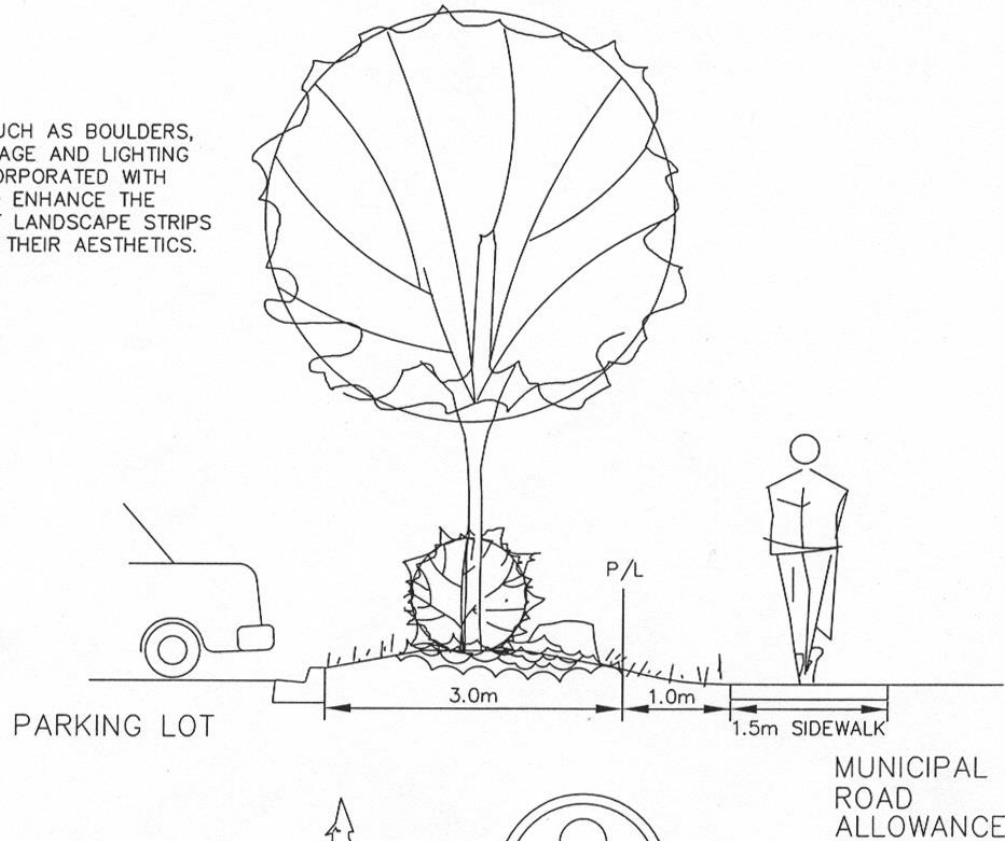

COMBINE SIGNAGE WITH A MIX OF CONIFEROUS AND DECIDUOUS TREES, SHRUBS & GROUND COVER OVER BERMS.

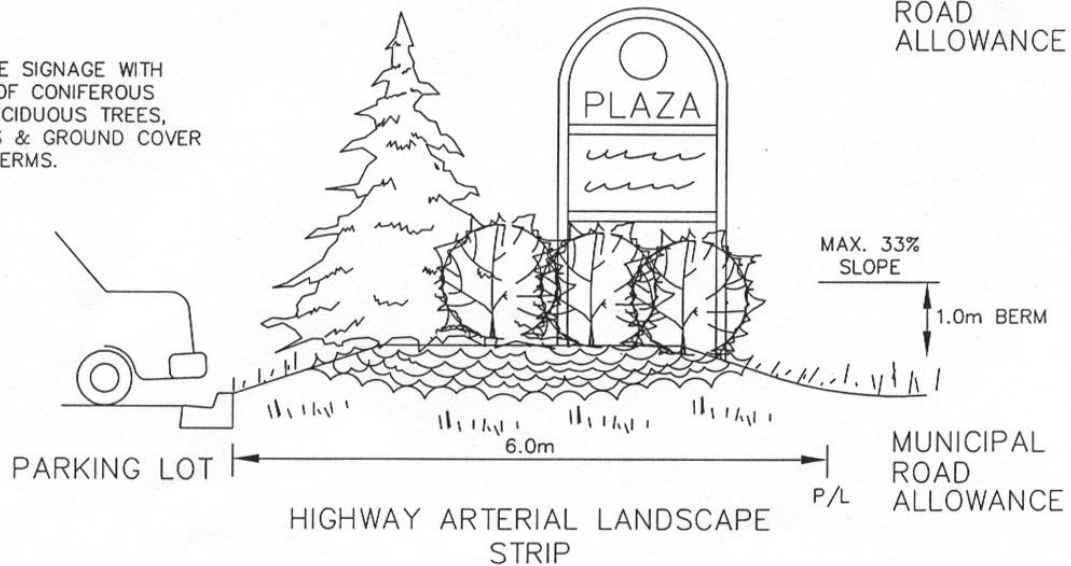

Typical Treatment of Front Landscape Strips.

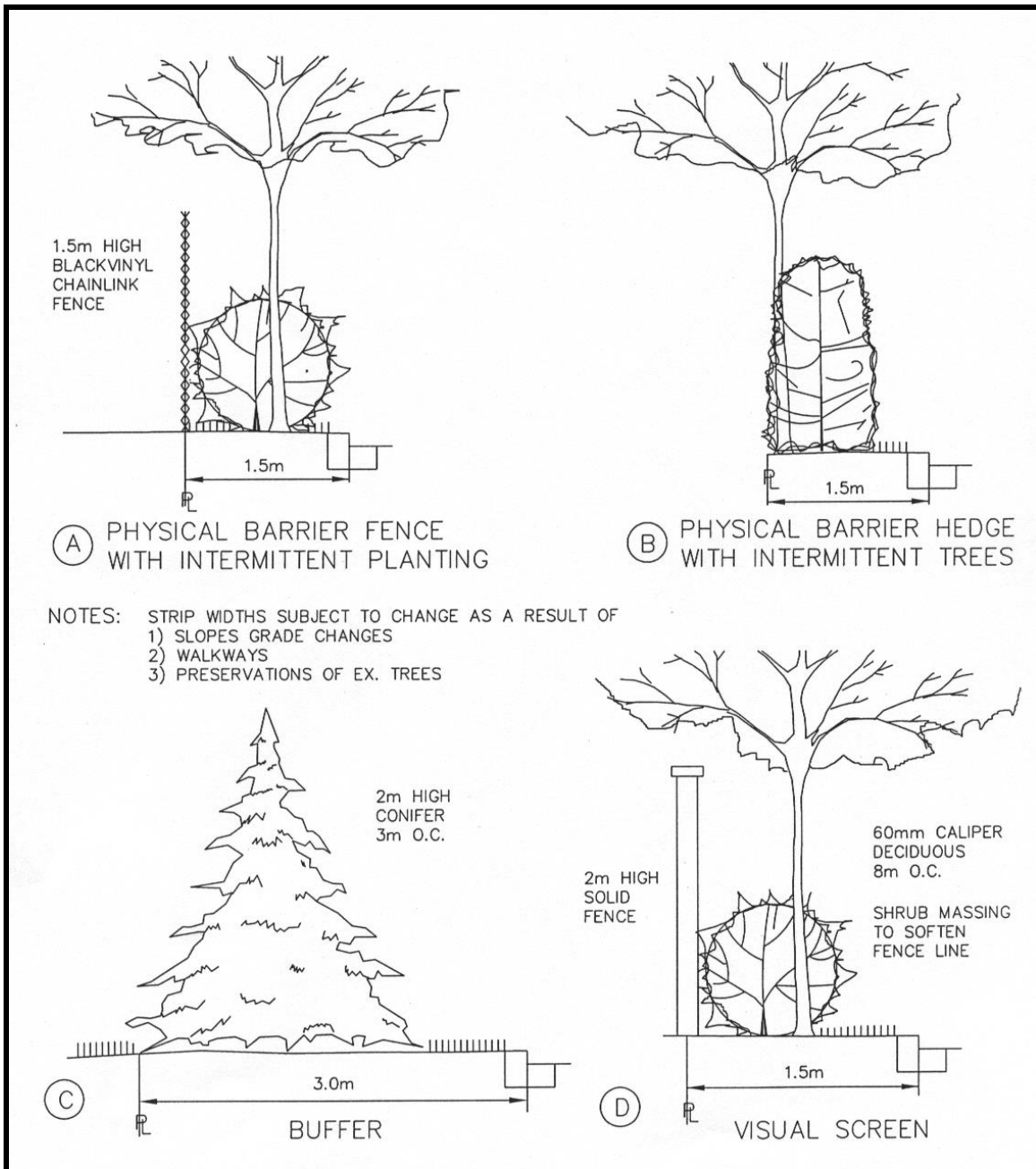

Typical Treatment of Side and Rear Landscape Strips.

B. The following tables outline the landscape strip **Standards** for specific land uses relative to their adjacent road classification and abutting land uses. Several factors may require an increase in the minimum landscape strip width including grade variations and the preservation of existing vegetation. The landscape treatments are **Guidelines** for the location and use of plant material, fencing, berming, etc. The planting density formula

establishes the desirable quantity of each type of plant material based on the proposed land use and the total site area

9.1.1 Landscape Strips - Office Buildings/Business Park Developments

Abutting Use	Landscape Strip Width Standards	Landscape Treatment Guidelines
Hwy 400	6m	<ul style="list-style-type: none"> • 1.8m high chain link fence • Mixed Deciduous and Evergreen trees • Berming and shrubs to screen parking lot • Foundation planting/Landscape islands
Arterial/ Parkway/Major Collector	6m	<ul style="list-style-type: none"> • Mixed Deciduous and Evergreen trees • Berming and shrubs to screen parking lot • Signage and entry feature shrub beds • Foundation planting/Landscape islands
Collector/Local	3m	<ul style="list-style-type: none"> • Mixed Deciduous and Evergreen trees • Berming and shrubs to screen parking lot • Signage and entry feature shrub beds • Foundation planting/Landscape islands
Schools	3m	<ul style="list-style-type: none"> • 1.8m high chain link fence • Deciduous tree planting with mixed shrub bed or hedging
Other Institutional	3m	<ul style="list-style-type: none"> • Deciduous tree planting with mixed shrub bed or hedging • 2m high solid fence if nursing/retirement home
Residential	3m	<ul style="list-style-type: none"> • 2m high Evergreen trees - 3m O.C. or 2m high solid fence (with 150mm x 150mm posts) with mixed tree shrub planting
Commercial	3m	<ul style="list-style-type: none"> • Deciduous tree planting with mixed shrub bed or hedging
Industrial	3m	<ul style="list-style-type: none"> • 2m high Evergreen trees – 3m O.C.
Open Space/E.P.	3m	<ul style="list-style-type: none"> • 1.5m high chain link fencing • Mixed Deciduous and Evergreen trees

Planting Density Formula Guideline

Total Site Area (m ²)	200 = # of Deciduous Trees	60mm CAL
Total Site Area (m ²)	400 = # of Evergreen Trees	2m HT
Total Site Area (m ²)	50 = # of Deciduous Shrubs	0.6-1.2m HT
Total Site Area (m ²)	100 = # of Evergreen Shrubs	0.45m SPR/1.2m HT

9.1.2 Landscape Strips - Commercial Developments (under 25,000m²)

Abutting Use	Landscape Strip Width Standards	Landscape Treatment Guidelines
Hwy 400	6m	<ul style="list-style-type: none"> • 1.8m high chain link fence • Mixed Deciduous and Evergreen trees • Berming and shrubs to screen parking lot • Foundation planting/Landscape islands
Arterial/ Parkway/Major Collector	6m	<ul style="list-style-type: none"> • Mixed Deciduous and Evergreen trees • Berming and shrubs to screen parking lot • Signage and entry feature shrub beds
Collector/Local	3m	<ul style="list-style-type: none"> • Mixed Deciduous and Evergreen trees • Signage and entry feature shrub beds
Schools	1.5m	<ul style="list-style-type: none"> • 1.8m high chain link fence • Deciduous tree planting with mixed shrub bed or hedging
Other Institutional	3m	<ul style="list-style-type: none"> • Deciduous tree planting with mixed shrub bed or hedging • 2m high solid fence if nursing/retirement home
Residential	3m	<ul style="list-style-type: none"> • 2m high Evergreen trees - 3m O.C. or 2m high solid fence (with 150mm x 150mm posts) with mixed tree shrub planting
Commercial	1.5m	<ul style="list-style-type: none"> • Deciduous tree planting with mixed shrub bed or hedging
Industrial	3m	<ul style="list-style-type: none"> • 2m high solid fence with Deciduous tree planting
Open Space/E.P.	3m	<ul style="list-style-type: none"> • 1.5m high chain link fencing • Mixed Deciduous and Evergreen trees

Planting Density Formula Guideline

Total Site Area (m ²)	300 = # of Deciduous Trees	60mm CAL
Total Site Area (m ²)	500 = # of Evergreen Trees	2m HT
Total Site Area (m ²)	50 = # of Deciduous Shrubs	0.6-1.2m HT
Total Site Area (m ²)	100 = # of Evergreen Shrubs	0.45m SPR/1.2m HT

9.1.3 Landscape Strips - Commercial Big Box Developments (over 25,000m²)

Abutting Use	Landscape Strip Width Standard	Landscape Treatment Guidelines
Hwy 400	9m	<ul style="list-style-type: none"> • 1.8m high chain link fence • Mixed Deciduous and Evergreen trees • Berming and shrubs to screen parking lot • Foundation planting/Landscape islands
Arterial/ Parkway/Major Collector	6m	<ul style="list-style-type: none"> • Mixed Deciduous and Evergreen trees • Berming and shrubs to screen parking lot • Signage and entry feature shrub beds • Foundation Planting
Collector/Local	6m	<ul style="list-style-type: none"> • Mixed Deciduous and Evergreen trees • Signage and entry feature shrub beds • Foundation Planting
Schools	3m	<ul style="list-style-type: none"> • 1.8m high chain link fence • Deciduous tree planting with mixed shrub bed or hedging
Other Institutional	3m	<ul style="list-style-type: none"> • Deciduous tree planting with mixed shrub bed or hedging • 2m high solid fence if nursing/retirement home
Residential	6m	<ul style="list-style-type: none"> • 2m high Evergreen trees - 3m O.C. or 2m high solid fence (with 150mm x 150mm posts) with mixed tree shrub planting
Commercial	1.5m	<ul style="list-style-type: none"> • Deciduous tree planting with mixed shrub bed or hedging
Industrial	3m	<ul style="list-style-type: none"> • 2m high solid fence with Deciduous tree planting
Open Space/E.P.	3m	<ul style="list-style-type: none"> • 1.5m high chain link fencing • Mixed Deciduous and Evergreen trees

Planting Density Formula Guidelines

Total Site Area (m ²)	400 = # of Deciduous Trees	60mm CAL
Total Site Area (m ²)	600 = # of Evergreen Trees	2m HT
Total Site Area (m ²)	100 = # of Deciduous Shrubs	0.6-1.2m HT
Total Site Area (m ²)	200 = # of Evergreen Shrubs	0.45m SPR/1.2m HT

9.1.4 Landscape Strips - Industrial Developments

Abutting Use	Landscape Strip Width Standards	Landscape Treatment Guidelines
Hwy 400	9m	<ul style="list-style-type: none"> • 1.8m high chain link fence • Mixed Deciduous and Evergreen trees • Berming and shrubs to screen parking lot
Arterial/ Parkway/Major Collector	6m	<ul style="list-style-type: none"> • Mixed Deciduous and Evergreen trees • Berming and shrubs to screen parking lot • Signage and entry feature shrub beds
Collector/Local	3m	<ul style="list-style-type: none"> • Mixed Deciduous and Evergreen trees • Signage and entry feature shrub beds
Schools	3m	<ul style="list-style-type: none"> • 1.8m high chain link fence
Other Institutional	3m	<ul style="list-style-type: none"> • 2m high Evergreen trees – 3m O.C. or 2m high solid fence with Deciduous trees
Residential	12m	<ul style="list-style-type: none"> • 2m high Evergreen trees - 3m O.C. or 2m high solid fence (with 150mm x 150mm posts) with mixed tree shrub planting
Commercial	3m	<ul style="list-style-type: none"> • Deciduous tree planting
Industrial	1.5m	<ul style="list-style-type: none"> •
Open Space/E.P.	3m	<ul style="list-style-type: none"> • 1.5m high chain link fencing • Mixed Deciduous and Evergreen trees

Planting Density Formula Guidelines

Total Site Area (m ²)	800	= # of Deciduous Trees	60mm CAL
Total Site Area (m ²)	1000	= # of Evergreen Trees	2m HT
Total Site Area (m ²)	400	= # of Deciduous Shrubs	0.6-1.2m HT
Total Site Area (m ²)	800	= # of Evergreen Shrubs	0.45m SPR/1.2m HT

9.1.5 Landscape Strips - School Developments

Abutting Use	Landscape Strip Width Standards	Landscape Treatment Guidelines
Hwy 400	9m	<ul style="list-style-type: none"> • 1.8m high chain link fence • Mixed Deciduous and Evergreen trees
Arterial/ Parkway/Major Collector	6m	<ul style="list-style-type: none"> • Mixed Deciduous and Evergreen trees • Berming and shrubs to screen parking lot • Signage and entry feature shrub beds • Berming and Evergreens to screen portables
Collector/Local	3m	<ul style="list-style-type: none"> • Mixed Deciduous and Evergreen trees • Signage and entry feature shrub beds • Berming and Evergreens to screen portables
Schools	1.5m	<ul style="list-style-type: none"> • Deciduous tree
Other Institutional	3m	<ul style="list-style-type: none"> • 1.8m high chain link fence with Deciduous trees • 2m high Evergreen trees – 3m O.C. or hedging if nursing/retirement home
Residential	3m	<ul style="list-style-type: none"> • 1.8m high chain link fence • 2m high Evergreen trees – 3m O.C. to screen parking and portables or Deciduous trees 15m O.C. with 1.5m high hedging
Commercial	1.5m	<ul style="list-style-type: none"> • 1.8m high chain link fence • Deciduous tree planting
Industrial	1.5m	<ul style="list-style-type: none"> • 1.8m high chain link fence • Deciduous tree planting
Open Space/E.P.	1.5m	<ul style="list-style-type: none"> • 1.8m high chain link fence • Deciduous tree planting

Planting Density Formula Guidelines

Total Site Area (m ²)	600 = # of Deciduous Trees	60mm CAL
Total Site Area (m ²)	800 = # of Evergreen Trees	2m HT
Total Site Area (m ²)	400 = # of Deciduous Shrubs	0.6-1.2m HT
Total Site Area (m ²)	600 = # of Evergreen Shrubs	0.45m SPR/1.2m HT

9.1.6 Landscape Strips - Other Institutional Developments

Abutting Use	Landscape Strip Width Standards	Landscape Treatment Guidelines
Hwy 400	6m	<ul style="list-style-type: none"> • 1.8m high chain link fence • Mixed Deciduous and Evergreen trees • Berming and shrubs to screen parking lot • Foundation planting
Arterial/ Parkway/Major Collector	6m	<ul style="list-style-type: none"> • Mixed Deciduous and Evergreen trees • Berming and shrubs to screen parking lot • Signage and entry feature shrub beds • Foundation planting
Collector/Local	3m	<ul style="list-style-type: none"> • Mixed Deciduous and Evergreen trees • Signage and entry feature shrub beds • Foundation planting
Schools	1.5m	<ul style="list-style-type: none"> • 1.8m high chain link fence • Deciduous tree planting with mixed shrub bed or hedging
Other Institutional	1.5m	<ul style="list-style-type: none"> • Deciduous tree planting with mixed shrub bed or hedging
Residential	3m	<ul style="list-style-type: none"> • 2m high Evergreen trees – 3m O.C. or 2m high solid fence (with 150mm x 150mm posts) with mixed tree and shrub planting
Commercial	1.5m	<ul style="list-style-type: none"> • 2m high solid fence if retirement/nursing home • Deciduous tree planting with mixed shrub bed or hedging
Industrial	1.5m	<ul style="list-style-type: none"> • 2m high solid fence with Deciduous tree planting
Open Space/E.P.	1.5m	<ul style="list-style-type: none"> • 1.5m high chain link fence • Mixed Deciduous and Evergreen trees

Planting Density Formula Guidelines

Total Site Area (m ²)	300 = # of Deciduous Trees	60mm CAL
Total Site Area (m ²)	500 = # of Evergreen Trees	2m HT
Total Site Area (m ²)	50 = # of Deciduous Shrubs	0.6-1.2m HT
Total Site Area (m ²)	100 = # of Evergreen Shrubs	0.45m SPR/1.2m HT

9.1.7 Landscaping Guidelines for Residential Developments

Abutting Use	Landscape Strip Width Standards	Landscape Treatment Guidelines
Hwy 400	12m	<ul style="list-style-type: none"> Noise attenuation fencing Mixed Deciduous and Evergreen trees 2m high berm with shrub massing Foundation planting
Arterial/ Parkway/Major Collector	6m	<ul style="list-style-type: none"> Entry feature/ornamental fencing Mixed Deciduous and Evergreen trees Berming and shrub beds Foundation planting
Collector/Local	3m	<ul style="list-style-type: none"> Entry feature/ornamental fencing Mixed Deciduous and Evergreen trees Shrub beds Foundation planting
Schools	3m	<ul style="list-style-type: none"> 1.8m high chain link fence Mixed Deciduous and Evergreen trees Mixed shrub bed or hedging
Other Institutional	3m	<ul style="list-style-type: none"> Mixed Deciduous and Evergreen trees Mixed shrub bed or hedging 2m high solid fence (with 150mm x 150mm posts)
Residential	3m	<ul style="list-style-type: none"> Mixed Deciduous and Evergreen trees Mixed shrub bed or hedging
Commercial	3m	<ul style="list-style-type: none"> 2m high solid fence (with 150mm x 150mm posts) Mixed Deciduous and Evergreen trees Mixed shrub bed or hedging
Industrial	3m	<ul style="list-style-type: none"> 2m high solid fence (with 150mm x 150mm posts) Mixed Deciduous and Evergreen trees Mixed shrub bed or hedging
Open Space/E.P.	3m	<ul style="list-style-type: none"> 1.5m high chain link fence Mixed Deciduous and Evergreen trees Mixed shrub bed or hedging

Planting Density Formula Guidelines

Total Site Area (m ²)	200 = # of Deciduous Trees	60mm CAL
Total Site Area (m ²)	400 = # of Evergreen Trees	2m HT
Total Site Area (m ²)	100 = # of Deciduous Shrubs	0.6-1.2m HT
Total Site Area (m ²)	200 = # of Evergreen Shrubs	0.45m SPR/1.2m HT

10.0 WATERFRONT

Protection and preservation of the City's waterfront has been one of the cornerstones of policy for the City of Barrie for a great number of years. This goal has been reflected in many of the City's long range planning documents including, but not limited to, the City's Strategic Plan and Official Plan.

The lakeshore is considered to be one of the primary attractions of the City of Barrie and it has long been the intent of the City's Official Plan to protect and expand public access to the waterfront. There remain many opportunities for development or redevelopment of lands located on the shoreline or adjacent to the waterfront.

DESIGN GUIDELINES

- A. *Ensure that future development within the City of Barrie minimizes impacts to the environmental health of the Kempenfelt Bay and the waterfront.*
- B. *Protect, restore and enhance whenever possible the topography and natural features along the waterfront in order that the natural ecological processes flourish.*
- C. *Maintain and restore connections with the natural and cultural heritage of the City.*
- D. *Incorporate connections with the historical past wherever possible into future waterfront plans and development.*
- E. *Ensure that future development or redevelopment particularly adjacent to or on the water's edge acknowledges the importance of keeping Kempenfelt Bay visually accessible and not compromised by creating visual barriers to the water.*
- F. *Ensure that all future development and redevelopment encourages continuous barrier-free access to the waterfront.*
- G. *Waterfront trails should have directional, and assistance signage and maps which are illuminated for night use.*
- H. *Parks and open spaces should have maximum street visibility for monitoring.*
- I. *Waterfront trails, parks and open spaces should provide direct links to surrounding areas.*
- J. *Provide lighting only in areas that are intended to support evening/night activities.*

DESIGN STANDARDS AND POLICIES

The City's Official Plan sets out a number of policies with respect to development or redevelopment along the waterfront.

1. Section 4.6.2.5 b) of the Official Plan states:

“Council shall promote the development of the waterfront lands along Kempenfelt Bay and Little Lake as a continuous major public open space system. No City owned lands will be disposed of in these areas and Council will attempt to acquire privately owned lands.”

2. Section 4.5.2.5 c) of the Official Plan states:

“ Development Applications may be permitted on waterfront lands by an amendment to this Plan. Where such amendments are being considered, the City may require the provision of a special study to review:

- i) the impact of such development on the environment and primary recreational function of the waterfront;
- ii) the impact of such development on the commercial and cultural vitality of the City Centre; and
- iii) the parking and access requirements of such a development, the deeding of waterfront lands or water lots to the City.

11.0 DEVELOPMENT ADJACENT TO RAILWAYS

The City of Barrie, through the Allandale Community Development Corporation, acquired the Canadian National Railways line that passed through the City. The acquisition and maintenance of a rail link to the Greater Toronto Area is key in achieving the City's goal of establishing commuter rail service to the City. The acquisition of the rail line is also essential in providing rail service to existing and future businesses and industries in the City.

DESIGN GUIDELINES

(Subject to Council's Consideration)

DESIGN STANDARDS AND POLICIES

(Subject to Council's Consideration)

12.0 TRANSIT

DESIGN GUIDELINES

- A. *Design for convenient pedestrian access with transit routes. Minimize walking distances between transit stops and primary activity areas.*
- B. *Locate buildings in commercial areas close to or at the property line to facilitate pedestrian access and encourage transit use.*
- C. *Coordinate transit stops with major activities, pedestrian routes and building entrance locations.*
- D. *Integrate, where appropriate internal transit movements and stops for public, commercial, industrial and institutional developments.*
- E. *Bike racks should be located near building entrances or in high foot traffic areas to increase pedestrian circulation for deterring potential offenders.*
- F. *Provide adequate lighting at transit stops.*
- G. *Transit shelters should be of transparent material to provide visual surveillance.*
- H. *Transit stops and shelters should be visible from the street and neighbouring buildings.*

DESIGN STANDARDS AND POLICIES

1. Large commercial and institutional developments are to be designed to:
 - i. Facilitate barrier free pedestrian access and future intensification.
 - ii. Have at least one building face with an entrance as close as possible and adjacent to an arterial road and transit stop.
 - iii. Have barrier free pedestrian access from the transit stop to the main building entrance.
 - iv. Have on-site lighting to maximize pedestrian safety.

APPENDICES

TABLE OF CONTENTS

APPENDIX 1	URBAN DESIGN GUIDELINE CHECKLIST	90
APPENDIX 2	TRANSPORTATION IMPACT STUDY REQUIREMENTS	97
APPENDIX 3	DEPARTMENTAL CONTACTS	107
APPENDIX 4	COMMUNITIES IN BLOOM	108
APPENDIX 5	HERITAGE BARRIE	110

APPENDIX 1

URBAN DESIGN GUIDELINE CHECKLIST

2.0 PHYSICAL ENVIRONMENT AND BUILDING SITING

	yes	n/a	Comments
A. Incorporate measures to address the physical environment.	()	()	_____
B. Ensure compatibility with adjacent area development.	()	()	_____
C. Respect existing scale and setbacks in the neighborhood.	()	()	_____
D. Incorporate natural features, vegetation and topography.	()	()	_____
E. Consider the quality of views and influences of sun and wind.	()	()	_____
F. Locate site services away from public & street view.	()	()	_____
G. Design building setback at a pedestrian scale.	()	()	_____
H. Locate active uses at the street level.	()	()	_____
I. Situate buildings to support public transit use.	()	()	_____
J. Reduce conflicts on multi-use sites.	()	()	_____
K. Site building to reduce visibility of parking areas.	()	()	_____
L. Incorporate energy saving designs and features.	()	()	_____
M. Minimize shadows cast on adjacent properties and outdoor uses.	()	()	_____
N. Provide a variety of reliefs and architectural elements.	()	()	_____
O. Consider future intensification and integration.	()	()	_____
P. Screen external transformers located on major road and areas of high visibility.	()	()	_____

3.0 SITE CIRCULATION

	yes	n/a	Comments
3.1 Pedestrian Circulation			
A. Provide pedestrian network from street to building, parking to building, and building to building.	()	()	_____
B. Provide pedestrian links to neighboring properties.	()	()	_____
C. Provide pedestrian walkways connecting municipal sidewalks to public institutions, offices, commercial, and multi-residential.	()	()	_____
D. Demarcate major pedestrian routes.	()	()	_____
E. Minimize pedestrian/vehicle crossings.	()	()	_____
F. Provide shelter and lighting at transit stops.	()	()	_____
3.2 Vehicle Circulation and Parking			
A. Design parking plans that are safe, convenient and easily understood.	()	()	_____
B. Provide appropriate signage and lighting.	()	()	_____
C. Locate parking areas close to building entrances.	()	()	_____
D. Include pedestrian circulation within parking areas.	()	()	_____
E. Link parking areas on abutting commercial properties.	()	()	_____
F. Pave parking and circulation routes.	()	()	_____
G. Clearly define primary vehicle routes.	()	()	_____
H. Provide right angle parking when possible.	()	()	_____
I. Avoid dead-end parking areas.	()	()	_____
J. Provide shopping cart corrals	()	()	_____
K. Use areas adjacent o buildings for walkways and landscaping.	()	()	_____
L. Provide landscaping around parking and laneways.	()	()	_____
M. Provide raised traffic islands.	()	()	_____
N. Provide ground cover in traffic islands other than sod.	()	()	_____
O. Ensure planting does not obstruct driver/pedestrian views.	()	()	_____
P. Provide landscaping features to provide shade and influence wind erosion and glare.	()	()	_____
Q. Provide areas for snow storage.	()	()	_____

	yes	n/a	Comments
3.3 Parking Structures			
A. Integrate ground level, street oriented uses.	()	()	_____
B. Provide barrier free parking close to entrances and elevators.	()	()	_____
C. Provide signage to indicate barrier free parking.	()	()	_____
D. Include following safety features:			
• adequate & uniform lighting;	()	()	_____
• clearly indicated exit route;	()	()	_____
• bright paint to improve lighting;	()	()	_____
• mirrors and circular columns.	()	()	_____
3.4 Access Driveways			
A. Reduce traffic conflict and confusion.	()	()	_____
B. Provide mutual driveways where appropriate.	()	()	_____
C. Ensure pedestrian safety & maximum visibility.	()	()	_____
D. Maximize distance between driveways & intersections.	()	()	_____
3.5 Drive-Through Facilities			
A. Provide sufficient stacking spaces.	()	()	_____
B. Avoid disruption of internal site circulation.	()	()	_____
C. Separate stacking lane from main parking areas.	()	()	_____
D. Screen from adjacent residential areas.	()	()	_____
E. Position boards & order stations away from residential uses.	()	()	_____
3.6 Emergency Access			
A. Provide ease of ingress/egress for emergency vehicles.	()	()	_____
B. Ensure site circulation accommodates emergency vehicles.	()	()	_____
C. Provide clear pedestrian passages to building.	()	()	_____
D. Identify location of hydrant/sprinkler connections.	()	()	_____

4.0 SITE SERVICES

	yes	n/a	Comments
A. Locate site services away form public and street view.	()	()	_____
B. Eliminate conflict between service access/site circulation.	()	()	_____
C. Eliminate reversing/maneuvering on public streets.	()	()	_____
D. Locate noise and odour sources away form sensitive uses & use attenuation measures where necessary.	()	()	_____
E. Screen outdoor storage.	()	()	_____
F. Locate recycling/garbage internal to a structure.	()	()	_____
G. Construct accessory recycling/garbage structures as fully building with a roof and a door/gate.	()	()	_____
H. Store all recycling and garbage bins within the structure.	()	()	_____
I. Provide interior waste storage for restaurants and food service buildings.	()	()	_____
J. Locate utilities underground.	()	()	_____

5.0 LIGHTING

A. Ensure fixtures are compatible with architecture and neighbourhood.	()	()	_____
B. Design site lighting to meet building and user needs.	()	()	_____
C. Use lighting to accentuate site features.	()	()	_____
D. Eliminate glare and light spillage.	()	()	_____
E. Used pedestrian scaled lighting.	()	()	_____
F. Coordinate lighting systems and landscaping.	()	()	_____

6.0 FENCING

A. Design fencing and other site elements to complement the architecture of the main building.	()	()	_____
B. Minimize visual monotony.	()	()	_____

	yes	n/a	Comments
7.0 ARCHITECTURAL DESIGN			
A. Ensure design is compatible with developing character of the neighbourhood.	()	()	_____
B. Ensure multiple buildings have a cohesive visual relationship.	()	()	_____
C. Coordinate exterior building design on all elevations.	()	()	_____
D. Orient buildings toward street/internal courtyard.	()	()	_____
E. Conceal rooftop mechanical equipment.	()	()	_____
F. Ensure buildings over 3 storeys in City Centre contribute to the skyline.	()	()	_____
G. Design rooftops with identifiable shapes.	()	()	_____
H. Emphasize main building entrance.	()	()	_____
I. Employ the effective use of building materials, architectural detail and lighting.	()	()	_____
J. Ensure buildings on corner lots have presence on both streets.	()	()	_____

7.2 Heritage Resources

A. Incorporate natural, historical, architectural or cultural resources.	()	()	_____
B. Conserve significant heritage resources.	()	()	_____
C. Incorporate existing architectural features.	()	()	_____
D. Site features to respect heritage resources.	()	()	_____

8.0 SIGNAGE

A. Integrate signs to complement the design of the building.	()	()	_____
B. Use materials found elsewhere in the project in the design of the ground sign.	()	()	_____
C. Ensure that new signs on existing buildings provide an appearance with existing signs.	()	()	_____
D. Provide uniform fascia signs.	()	()	_____
E. Provide for convenient and attractive replacement of signs.	()	()	_____
F. Accommodate mobile signs in appropriate landscaped areas.	()	()	_____

	yes	n/a	Comments
G. Ensure that mature landscaping and signage work in harmony.	()	()	_____
H. Provide street address numbers for identification.	()	()	_____

9.0 LANDSCAPE DESIGN

A. Promote preservation of existing natural features.	()	()	_____
B. Ensure a harmonies integration of landscape features.	()	()	_____
C. Use ecologically sound and appropriate seasonal plant material.	()	()	_____
D. Provide landscaped traffic islands to delineate primary traffic routes.	()	()	_____
E. Landscape to delineate boundaries and establish streetscape appeal.	()	()	_____
F. Use landscaping to screen parking/site services.	()	()	_____
G. Relate landscape treatment to their function.	()	()	_____
H. Landscape areas outside building entrance(s) to define its function.	()	()	_____
I. Use plant material for scale, definition & softening.	()	()	_____
J. Provide appropriate site amenities and furnishings.	()	()	_____
K. Preserve healthy trees where possible.	()	()	_____
L. Use plant species suitable for the local climate.	()	()	_____

9.2 Landscape Strips

A. Provide landscape strips adjacent to roadways and lot lines.	()	()	_____
B. Provide appropriate landscape treatments and planting density based on the proposed lands use, site area and abutting land use.	()	()	_____

10.0 WATERFRONT

	yes	n/a	Comments
A. Minimize the impacts on Kempenfelt Bay.	()	()	_____
B. Protect, restore & enhance the natural features along the waterfront.	()	()	_____
C. Maintain & restore natural and cultural connections.	()	()	_____
D. Incorporate connections with historical past.	()	()	_____
E. Keep Kempenfelt Bay visually accessible.	()	()	_____
F. Ensure barrier-free access to the waterfront.	()	()	_____

11.0 DEVELOPMENT ADJACENT TO RAILWAYS

(subject to Council's consideration)

12.0 TRANSIT

A. Design for pedestrians.	()	()	_____
B. Locate commercial buildings close to or at the property line.	()	()	_____
C. Coordinate transit with major activities.	()	()	_____
D. Integrate internal transit movements where appropriate.	()	()	_____

APPENDIX 2

TRAFFIC IMPACT STUDY REQUIREMENTS

The following is a brief outline of the requirements for a transportation impact study prepared in support of a development application or proposal. Since these are guidelines, some sections may not apply to the particular proposal under consideration. If, in the opinion of the City, data and/or analysis are deemed to be missing, the report may be returned to the author for further revision.

1. TITLE PAGE

2. TABLE OF CONTENTS

LIST OF EXHIBITS

LIST OF APPENDICES

3. EXECUTIVE SUMMARY

- Key findings of the study.

4. INTRODUCTION

4.1 Identification of the Applicant

4.2 Site Location

- Description of the site's location and a map showing the site in area context.

4.3 Nature of the Application

- Description of the contents and purpose of the Official Plan amendment, zoning amendment, subdivision, site plan proposal, etc.

4.4 Summary of the Key Issues

5. CONTEXT

5.1 Study Area

- Include map(s) to show study area. The study area should include all Arterial and Provincial roads, expressways, intersections, interchanges, transit services and facilities, etc., which will be noticeably affected by the proposed

development (i.e., intersection level of service affected by more than 5%, volume/capacity ratio of individual intersection traffic movements increased to more than 0.85 in urban areas or more than 0.70 in rural areas, change in traffic control, etc.)

5.2 Proposed Land Use on the Site

- Description of the type of land uses proposed, including the size of the individual land use components expressed in units related to transportation analysis (i.e. floor area, number of residential units, population, employment, number of parking spaces, etc.). Special attention should be paid to gross vs. net definitions.
- Identification of any phasing schemes with their associated land use statistics.
- Expected dates of completion and full occupancy of the ultimate development and of any interim phases, if known.

5.3 Other Developments in the Study Area

- Identify other developments under construction, approved or in the approval process within the study area, along with the type and size of development.

5.4 Transportation System

- Include map(s) to show the existing transportation system in the study area.
- The system should be outlined, including:
 - a) Existing roads, jurisdiction, number of lanes, posted speeds.
 - b) Existing signalized intersections, lane configuration, restrictions on movements.
 - c) Other traffic controls, restrictions on movements.
 - d) Heavy vehicles (truck) restrictions.
 - e) Existing transit routes and service frequencies.
 - f) Existing transit stops and stations.
 - g) Adjacent and opposite driveways and other site access.
 - h) Other features of interest.

5.5 Committed and Proposed Transportation Improvements

- Identify the nature and timing of such transportation system improvements within the study area or which may affect transportation to/from the proposed development.

6. TRAVEL DEMAND

6.1 Horizon Years

- The horizon years should be at least ten years from the date of the study or at least five years from the date of full occupancy, if the date for full occupancy of the project can be identified.
- Horizon years should also be identified for interim phases of development.

6.2 Time Period for Analysis

- In general, the morning and afternoon peak hours should be evaluated. The peak hours should be identified on the basis of the “worst-case” combination of site-generated trips plus background traffic/transit volumes across the study area.
- Other peak hours, such as Saturday afternoons or Friday evenings for retail uses, should be examined to see if they will result in a “worst-case” situation in any respect.
- A noontime peak time may have to be analyzed for developments containing eating establishments, particularly fast food outlets.
- If truck traffic generated by a site is significant, then the times and volumes should be specified and included in the analysis.

6.3 Time Period for Analysis

- The existing traffic volumes in the study area should be shown on a map. The volumes should be based on the most recent traffic/transit available. The consultant should undertake additional traffic counts where existing count data is more than two years old or where existing data appears to be anomalous or is insufficient. Transit counts should be based on the peak points of the routes involved.

- If recent counts are not available, new data should be gathered to cover the time periods 7:00 – 9:00, 11:00 – 14:00, and 16:00 – 18:00 on a typical weekday, plus any other relevant peak period. Such a peak period may include Friday nights or Saturday afternoons for major shopping centers. Copies of the data collected should be forwarded to the Operations Department.

6.4 Evaluation of Background Traffic/Transit Volumes

- Existing traffic/transit volumes should be factored to account for growth between the date of the counts used and the horizon year(s). Growth factors may be based on historical trends or other documented and justified methodology. This component of background traffic growth will be deemed to represent travel increases resulting from general growth outside the study area.

6.5 Site-Generated Traffic/Transit Volumes

- Trip generation, trip distribution, assignment and model split assumptions should be in accordance with standard and accepted parameters and techniques or based on surveys or other local knowledge. Sources should be well documented and any assumptions which may be considered less than conservative should be rigorously justified. Any “soft” parameters where there is significant uncertainty or a range of possible values should be subjected to sensitivity analysis unless a demonstrated “worst-case” situation is assumed.
- Assumed travel demand parameters (generation, distribution, modal split, etc.) should be documented and justified in terms of previous research or surveys.
- Specific assumptions, such as reduction for “on-site synergy” or “pass-by” trips should be documented and justified in terms of previous research or surveys.

6.6 Traffic/Transit Volumes

- Figure(s) should be presented indicating the assignment of all site-generated traffic volumes to the local road network, as well as the individual site access locations.
- Map(s) should be included to summarize the following:

- a) existing traffic/transit volumes;
 - b) existing plus background growth; and
 - c) existing plus background growth plus site-generated volumes.
- The morning and evening peak hours and any other relevant peak hours should be summarized.
 - The horizon years for full occupancy and for any interim phases should be presented.
 - Major transportation improvements, committed or planned within the study horizon, which may significantly affect the travel demand pattern associated with the development proposal should be considered. Scenarios with and without such improvements should be summarized as appropriate.

7. EVALUATION OF IMPACTS

- The evaluation of impacts should be conducted for all the time periods of each horizon year as appropriate. The existing situation, existing plus background growth, and existing plus background growth plus site-generated traffic should be included, including the scenarios with and without any relevant major transportation system improvements.

7.1 Traffic Impacts

- All site access locations and all relevant signalized and major unsignalized intersections in the study area should be evaluated. The operational analysis for intersections in the study area should be evaluated. The operational analysis for intersections should be conducted using generally recognized and approved methods.
- All assumptions concerning lane configuration and use, pedestrian activity, cycle length, signal phasing, and signal timing should be documented. The consultant should confirm that any assumptions are in compliance with City standards and/or practices.
- The traffic volumes and volume/capacity ratios should be documented in a clearly understandable table in an appendix for all signalized intersections. The overall V/C ratio for each individual movement should be presented.

- Traffic volumes and volume/capacity ratios for all “problem” intersections or individual movements should be summarized in a table in the body of the report. Problem intersections and movements include:
 - a) an intersection where the overall volume/capacity ratio will exceed 0.85 in urban areas or 0.70 in rural areas;
 - b) an individual movement volume/capacity ratio will exceed 0.85 in urban areas or 0.70 in rural areas; or
 - c) an exclusive turning movement which will result in queues which exceed the available storage space.
- The table should include the volume/capacity ratios for the following:
 - a) the existing situation;
 - b) the existing plus background growth; and
 - c) the existing plus background growth plus the site-generated traffic and for scenarios involving general improvements to the transportation system.
- All level of service analysis of existing volumes and movements at major signalized intersections where volume/capacity ratios will exceed 0.85 should be supplemented by field evaluation of average delays and queue lengths. Evaluation of future traffic scenarios should be supplemented by estimates of these parameters as available from the capacity analysis technique used.
- All intersections or individual movements identified as “problems” should be discussed in terms of contribution of the development proposal to the situation, possible remedial measures, a recommended solution and the effectiveness of the solution towards resolving the situation. In general, the objective should be to ensure that no new “problem” movements are created by the development and that “problem” movements which exist without the addition of site-generated traffic are not worsened by this addition.
- All exclusive turning lanes used by site-generated traffic should be examined to ensure adequate storage space.

- All proposed new traffic signals should be evaluated in terms of signal warrants, distance from other signals, effects on existing signal coordination, likely timing of implementation, etc.
- All proposed adjustments to cycle length, signal phasing and signal timing should be evaluated in terms of pedestrian crossing time, effect on queue length and adequacy of existing storage, modifications required to existing signals and controllers and effects on existing signal coordination.
- All methodologies and assumptions should be documented as to the source and their uses should be justified.

7.2 Traffic Impact Analysis

- Existing transit services should be evaluated in terms of available capacity and need for increased service. The need for new transit services should be evaluated, particularly if there are vehicle capacity problems at intersections.
- Pedestrian access to transit services from the proposed developments should be evaluated and desirable improvements to the site plan to facilitate access should be noted and/or recommended.
- Any impacts on transit operations caused by site-generated traffic should be identified and suitable remedial measures noted and recommended.
- Any required relocation of transit facilities, such as bus stops, should be identified and alternative location determined and evaluated regarding their effects on traffic and transit operations.

8. REMEDIAL MEASURES

- All transportation systems improvements identified as necessary or desirable to serve the proposed development should be listed and the timing of their implementation should be identified.
- All road improvements should be shown on a functional sketch indicating dimensions, required pavement widenings and required right-of-way widenings.
- All “problem” traffic movements or other traffic/transit impacts that cannot be successfully mitigated should be identified.

- A table should be prepared to show how the volume/capacity ratios of the intersections and individual movements are affected by the recommended remedial measures.

9. SITE ACCESS AND CIRCULATION

- All site access points on Arterial roads should be evaluated in terms of capacity, safety and adequacy of queue storage capacity. This evaluation should be similar in scope to that for signalized and unsignalized intersections described previously.
- Proposed access points should be evaluated with respect to possible mutual interference with other access points and intersections, on-street weaving problems, need for acceleration or deceleration lanes, pedestrian safety, etc.
- On-site parking and circulation systems should be evaluated to demonstrate a high safety factor with respect to the possibility of queues backing onto Arterial roads, the need for vehicles to back onto Arterial roads, etc.
- Sight line should be evaluated to ensure safe conditions in accordance with accepted standards where these are affected by site design.
- Proposed truck/courier loading facilities and access to these facilities should be evaluated to ensure that they are adequately sized, designed and provided with suitable access to that they will not adversely affect traffic and transit operations on City roads.
- Any required turning or other restrictions should be identified.
- Generally, it is preferable to minimize the number of private site accesses to Arterial Roads, in order to maintain the integrity of the arterial road network. Site access should be provided only to the local road network wherever possible. Benefits to the Arterial Road network should be demonstrated when an access is proposed.

10. CONCLUSIONS AND RECOMMENDATIONS

- A summary of the key findings with respect to the transportation impact of the proposed development should be presented along with a summary of the recommended improvements and resolved “problems”.

APPENDICES

APPENDIX – SUGGESTED TABULAR FORMATS

Trip Generation

Land Use	Size	Trip Rate (/100 s.m.)				Trips (Vel/hour)			
		Morning		Evening		Morning		Evening	
		In	Out	In	Out	In	Out	In	Out
Office, etc.	2000 s.m.	2.3	0.4	0.5	2.3	46	8	10	46

Trip Distribution

Direction	Distribution			
	Morning		Evening	
	In	Out	In	Out
To/from the north				
- via Street A	100	10	10	120
- via Street B	15	60	50	200
To/from the east, etc.				
TOTAL	350	450	450	350

Analysis Impact Summaries

PM Peak Hour V/C ratios Intersection/Movement	Existing	Forecast Without Site	Forecast With Site
Street A/B			
- all moves	0.73	0.83	0.87
- problem moves - NB LT	0.80	0.85	0.95
- problem moves – EB LT	0.89	0.92	0.98

etc.

Notes should be provided with the table to allow reference to an appendix which would further detail ALL of the operational analysis. The table as shown above summarizes the peak hours only. It will be necessary to develop tables for other information, such as queuing, weaving information, etc.

APPENDIX 3

DEPARTMENTAL CONTACTS

Planning and Development Services

Planning Services Department	(705) 739-4208	Fax (705) 739-4270
Building Department	(705) 739-4212	Fax (705) 739-4240

Works and Community Services

Engineering Department	(705) 739-4207	Fax (705) 739-4247
Design and Construction Services	(705) 739-4210	Fax (705) 739-4248
Infrastructure Planning Branch (Traffic)	(705) 739-4220	Fax (705) 739-4245
	Ext. 4382	
Infrastructure Planning Branch (Parks)	(705) 739-4220	Fax (705) 739-4245
	Ext. 4342	
Fire & Emergency Services (65 Vespra St., Barrie L4N 2H8)	(705) 728-3199	Fax (705) 728-4439

Police Department

(29 Sperling Drive, P.O. Box 188, Barrie, L4M 4T2)	(705) 725-7025	Fax (705) 728-2179
--	----------------	--------------------

External Agencies

Barrie Hydro (55 Patterson Road, Barrie L4N 3A3)	(705) 722-7222	Fax (705) 722-6168
Nottawasaga Valley Conservation Authority	(705) 424-1479	Fax (705) 424-2115
Lake Simcoe Region Conservation Authority	(905) 895-1281	Fax (905) 895-5881
Simcoe County District Health Unit	(705) 721-7330	Fax (705) 721-1495

APPENDIX 4

COMMUNITIES IN BLOOM

Communities in Bloom is a national municipal beautification contest with a focus on flowers, landscaping, gardens, beautification and environmental awareness. The Communities in Bloom competition consists of municipalities being evaluated on the accomplishments of their whole community (municipal, corporate and individual citizens) on any of the following criteria:

- Landscaped Areas;
- Floral Arrangements;
- Community Involvement;
- Turf Areas;
- Tidiness Effort;
- Urban Forestry Development;
- Environmental Efforts; and
- Heritage Conservation

Barrie has been participating in the Communities in Bloom for the past 5 years. 1998 was Barrie's first year of competition in the Communities in Bloom Program. Barrie participated in the 50,000 - 100,000 population category at the Provincial level, winning the category.

In 1999, the City of Barrie competed in the 50,000 - 100,000 population category in the National Communities in Bloom Program and was awarded a 4 out of 5 Bloom ranking. Barrie also received special recognition for its floral displays along the waterfront and in private gardens located throughout the community.

In 2000, Barrie moved up to the 100,001 - 300,000 population category (by special invitation). The City of Barrie was awarded a 4 Bloom ranking at the National Communities in Bloom Awards Ceremony held in Edmonton, Alberta on September 30, 2000. Barrie's 4 out of a possible 5 Bloom ranking placed it in second place standing overall. Barrie was the first city to receive a 4 Bloom ranking after competing only once in the 100,001-300,000 population category. Barrie received further recognition for its excellence in Landscaping and Floral Displays (two of the major judging criteria).

In 2001, the City of Barrie was presented with a 5 Bloom ranking and the National Capital Commission's award at the National Communities in Bloom Awards Ceremony held in Greater St. John, New Brunswick on September 22nd. The 5 Bloom ranking is the first place ranking in the Communities in Bloom Program. Other communities in the 100,001-300,000 population category included Greater Sudbury, ON, Richmond Hill, ON, Saskatoon, SK, Coquitlam, BC, and Abbotsford, BC.

The National Capital Commission Award is the most prestigious award for beautification efforts at the national level. Barrie received further recognition for its excellence in Floral Displays (a major judging criteria).

In 2002, Barrie partnered with the Parish of St. Helier on the Island of Jersey in the English Channel for the International Level in the Communities in Bloom competition. In the International Challenge Category, past winners of Communities in Bloom are twinned with past winners of European contests.

The City of Barrie and the Parish of St. Helier were named the winners in the International Challenge category of the 2002 Edition of Communities in Bloom. The judges who evaluated Barrie and St. Helier commented that they were most impressed with the involvement at all levels of the community. They noted that both communities evidenced pride, a sense of community and a feeling of accomplishment.

APPENDIX 5

HERITAGE BARRIE

Heritage Barrie is an advisory committee comprised of no fewer than nine members appointed by Council and established pursuant to the Ontario Heritage Act.

Heritage Barrie's major responsibilities are as follows:

1. To establish the criteria for the evaluation of properties of architectural or historical value.
2. To prepare and maintain a list of all properties worthy of conservation under the Heritage Act.
3. To keep current on all heritage conservation legislation and programs and recommend to Council any programs worthy of consideration by the City.
4. To provide information to property owners about the preservation of heritage properties and supply information about conservation of such properties.
5. With Council's permission, to seek grants and programs to hire staff, in accordance with City procedures, to fulfill these major responsibilities.

Heritage Barrie's other responsibilities include the following:

1. To recommend action to Council on matters relating to heritage buildings as identified in item 2, with regard to applications for demolition, alteration or construction.
2. To educate the public on matters relating to heritage through various programs such as plaques, maps and walking tours.
3. To solicit funds from the community to support Heritage Barrie programs approved by Council.
4. To administer all documents and artifacts acquired by the City under the Heritage Act as approved by Council, from time to time.
5. To advise Council on matters of local history.
6. To advise through Council, all City Committees with regard to the preservation of heritage structures and features.